

SILENT KNIGHT MODEL 2720 CONTROL/COMMUNICATOR

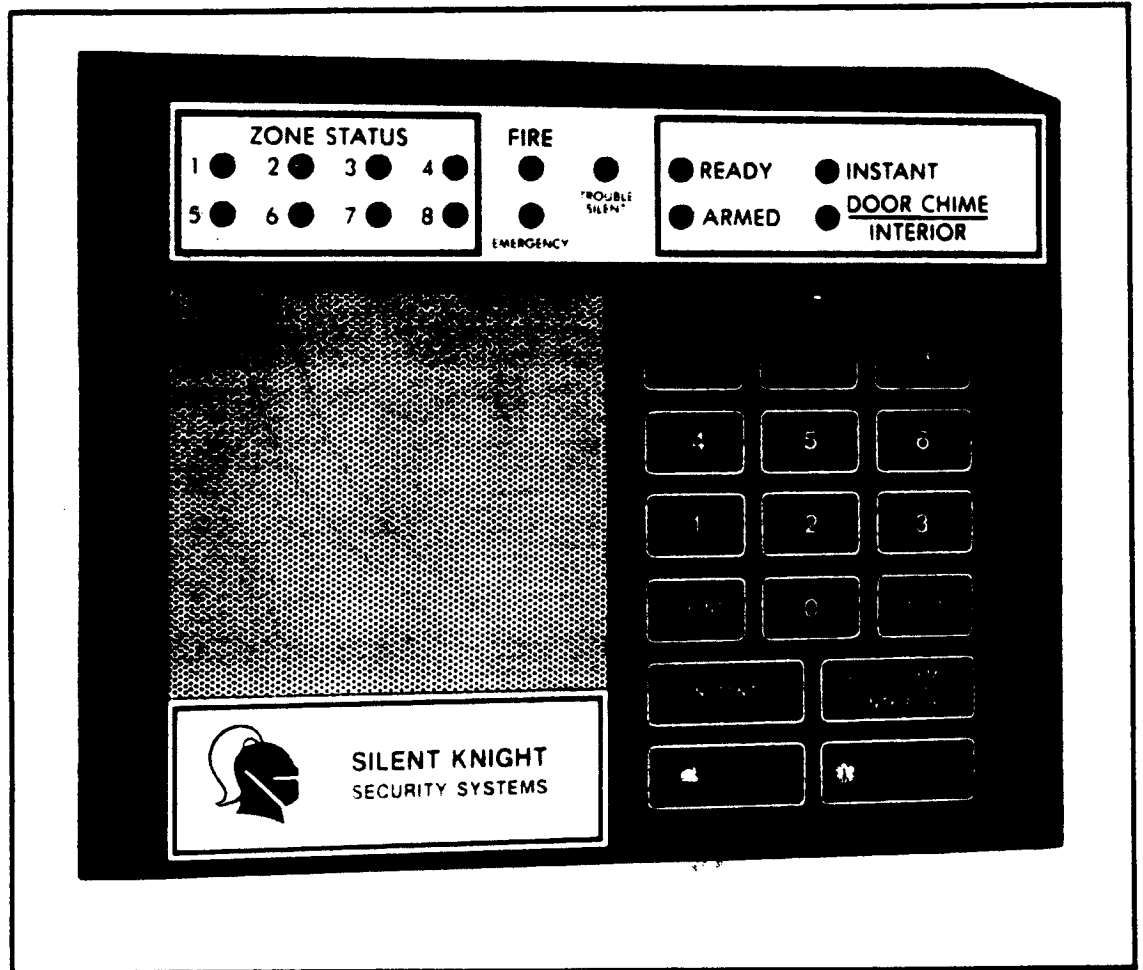

INSTALLATION MANUAL

SILENT KNIGHT
SECURITY SYSTEMS
DIVISION OF WAYCROSSE, INC.



1700 FREEWAY BLVD. NORTH
MINNEAPOLIS, MN 55430
TELEPHONE 612/566/0510

IMPORTANT: Silent Knight products should be tested every month (under no circumstances less than every three months) to insure complete and proper operation and proper input and output connections.

LIMITED WARRANTY

Silent Knight Security Systems warrants that the products of its manufacture shall be free from defects in materials or workmanship for one year from the date of invoice if such goods have been properly installed, are subject to normal proper use, and have not been modified in any manner whatsoever. Upon return of the defective product to the nearest Silent Knight dealer, Silent Knight will, at its sole discretion, either repair or replace, at no cost to the customer, such goods as may be of defective material or workmanship. Customers outside the United States are to return products to their distributor for repair.

SILENT KNIGHT SECURITY SYSTEMS SHALL NOT UNDER ANY CIRCUMSTANCES BE LIABLE FOR ANY INCIDENTAL OR CONSEQUENTIAL DAMAGES ARISING FROM LOSS OF PROPERTY OR OTHER DAMAGE OR LOSSES OWING TO THE FAILURE OF SILENT KNIGHT SECURITY SYSTEMS PRODUCTS BEYOND THE COST OF REPAIR OR REPLACEMENT OF ANY DEFECTIVE PRODUCTS.

SILENT KNIGHT SECURITY SYSTEMS MAKES NO WARRANTY OF FITNESS OR MERCHANTABILITY AND NO OTHER WARRANTY, ORAL OR WRITTEN, EXPRESS OR IMPLIED, BEYOND THE ONE YEAR WARRANTY EXPRESSLY SPECIFIED HEREIN.

TABLE OF CONTENTS

INTRODUCTION.....	1
TELEPHONE REQUIREMENTS.....	1
FCC REQUIREMENTS.....	1
FEATURES.....	2
CONTROL PANEL DESCRIPTION.....	3
AC POWER TRANSFORMER.....	3
BATTERY CABLES.....	3
FUSES.....	3
DC POWER SWITCH.....	3
CONTROL EEPROM.....	3
AC POWER LIGHT.....	5
DIALER EEPROM.....	5
CONNECTOR P1.....	5
CONNECTOR P4.....	5
TROUBLE ALERT VOLUME CONTROL.....	5
ACCESSORIES.....	5,6
PROGRAMMING.....	7
EEPROMS.....	7
PROM REMOVAL.....	8
PROM INSERTION.....	8
FACTORY PROGRAMMED EEPROMS.....	8
PROGRAMMING USER ACCESS CODES.....	8
MODEL 2720 REPORTING FORMATS.....	9
MODEL 2724 REPORTING FORMATS.....	9,10
SILENT KNIGHT 3/1 AND SESCOA 3/1 FORMATS.....	9
SILENT KNIGHT FSK AND 4/2 FORMATS.....	9
2720 CONTROL PANEL INSTALLATION.....	12
1. SELECT A LOCATION.....	12
2. MOUNT THE 2720.....	12
3. INSTALL THE 9220 POWER TRANSFORMER.....	12
4. CONNECT ALL INITIATING DEVICES & ACCESSORIES.....	13
5. CONNECT POWER TO THE 2720.....	13
ZONE FEATURES AND OPTIONS.....	14
PROGRAMMED OPTIONS AND TIMING SELECTIONS.....	14-16

ZONE WIRING AND PROGRAMMING.....	16
1. END-OF-LINE RESISTORS.....	16
2. ZONE CONFIGURATION EXAMPLE.....	18
3. PROGRAMMING THE ZONE CONFIGURATION EXAMPLE.....	18
4. MODEL 7620 SMOKE DETECTOR.....	19
5. EMERGENCY ZONE WIRING.....	19
PROGRAMMING DIALER OPTIONS.....	20
ACCESSORY WIRING.....	20
1. EXTERNAL ALARM BELL OR SIREN.....	20
2. GROUND START RELAY.....	21
3. EXTERNAL DIALER FAILED INDICATOR.....	21
4. TELEPHONE LINE WIRING.....	22
5. MECHANICAL KEY FOR ARMING/DISARMING.....	23
6. MODEL 2070 DIGITAL KEYSTATION WIRING.....	23
7. MODEL 2069 KEYSTATION WIRING.....	23
8. MODEL 7040 EMERGENCY MODULE.....	24
MODEL 2720 WIRING DIAGRAM.....	25
TERMINAL STRIP DESCRIPTION.....	26
MODEL 2070 DIGITAL KEYSTATION.....	27
ZONE STATUS LED'S 1-8.....	27
FIRE LED.....	27
EMERGENCY LED.....	27
TROUBLE SILENT LED.....	27
READY LED.....	27
ARMED LED.....	27
INSTANT LED.....	27
DOOR CHIME/INTERIOR LED.....	27
NIGHT LIGHT.....	28
BUILT-IN SPEAKER.....	28
SYSTEM OPERATION.....	29
DIGITAL KEYSTATION INSTALLATION.....	30
MODEL 2720 WITH INTERCOM.....	31
INTERCOM OPERATION.....	31
INSTALLATION OF THE MODEL 1520L OR 1522L RF RECEIVER.....	31
RF ZONE - 2720 ZONE CROSS REFERENCE.....	33
INSTALLING THE MODEL 5255 ON-SITE PRINTER.....	33
TRANSIENT VOLTAGE PROTECTION.....	34
EARTH GROUND.....	34

2720 EARTH GROUND CONNECTIONS.....	34
BATTERY TESTING.....	34
SPECIAL APPLICATION SECTION.....	35-40
POST INSTALLATION TEST.....	40
MODEL 2720 TROUBLESHOOTING GUIDE.....	41,42

LIST OF ILLUSTRATIONS

FIGURE 1 - MODEL 2720 CIRCUIT BOARD.....	4
FIGURE 2 - MODEL 9220 TRANSFORMER.....	13
FIGURE 3 - MODEL 2720 ZONE WIRING.....	17
FIGURE 4 - MODEL 7620 SMOKE DETECTOR.....	19
FIGURE 5 - EMERGENCY ZONE WIRING.....	19
FIGURE 6 - EXTERNAL BELL WIRING.....	20
FIGURE 7 - GROUND START RELAY.....	21
FIGURE 8 - DIALER FAILED INDICATOR.....	22
FIGURE 9 - TELEPHONE WIRING.....	22
FIGURE 10 - MECHANICAL KEY WIRING.....	23
FIGURE 11 - MODEL 7040 WIRING DIAGRAM.....	24
FIGURE 12 - MODEL 2720 WIRING DIAGRAM.....	25
FIGURE 13 - MODEL 2070 DIGITAL KEYSTATION.....	28
FIGURE 14 - KEYSTATION INSTALLATION.....	30
FIGURE 15 - MODEL 2720 INTERCOM WIRING DIAGRAM.....	32
FIGURE 16 - SHOPPING MALL APPLICATION.....	36
FIGURE 17 - MODEL 3500 TO 2720 WIRING DIAGRAM.....	37

INTRODUCTION

The Silent Knight Model 2720 is a combination Control/Communicator which features 8 intrusion zones, a supervised fire zone and a supervised emergency input. The Model 2720 provides remote access and zone annunciation capabilities through the use of the Model 2070 Digital Key Module. The Model 2720 combines all the features of a versatile residential control panel with the features and reliability of a commercial unit. Telephone and option information is stored in two Electrically Erasable PROMs (EEPROMs), which prevent the loss of this information when all power is removed and allow reprogramming up to 1000 times. For the purposes of this installation manual, all reference to the Model 2720 also applies to the Model 2724 unless otherwise noted.

TELEPHONE REQUIREMENTS

1. Before connecting this device to the phone lines the telephone company must be notified and provided with the following information:

- A. Manufacturer - Silent Knight
- B. Model Number - 2720
- C. FCC registration number - AC698R-69183-AL-R
- D. Type of jack (to be installed by the telephone company) - RJ31X

NOTE: The telephone company must also be notified if this device is permanently disconnected.

2. This device may not be directly connected to coin telephone or party line services.

3. The telephone company under certain circumstances may temporarily discontinue services and/or make changes in its facilities and services which may affect the operation of this device; however, the telephone company is required to give adequate notice in writing of such changes or interruptions.

4. This device cannot be adjusted or repaired in the field; in case of trouble with the device notify the installing company or return to:

SILENT KNIGHT SECURITY SYSTEMS
1700 Freeway Blvd. N.
Minneapolis, MN. 55430
Phone (612) 566-0510

F.C.C. REQUIREMENTS

WARNING: This equipment generates and uses radio frequency energy and if not installed and used in strict accordance with this manual, may cause harmful interference to radio communications. It has been tested and found to comply with the limits for a class A computing device pursuant to Subpart J of Part 15 of FCC Rules, which are designed to provide reasonable protection against such interference when operated in a commercial environment. Operation of this equipment in a residential area is likely to cause interference in which case the user will be required, at his own expense, to take whatever measures may be required to correct the interference.

FEATURES

- * 8 Intrusion Zones - each independently programmed for desired features such as Exit/Entrance Delay, Interior Zone, 24 hour Zone, Silent Zone, Delayed Detection, ability to be Shunted and choice of N.O. or N.C. contacts.
- * 1 supervised Emergency and 1 supervised Fire Zone.
- * 10 Access Codes - used to Arm/Disarm system. If Open/Close Reporting option is selected, User Code is reported to identify who Armed or Disarmed system. Access Codes are reprogrammable from Digital Key Station. Options to give different codes different levels of access.
- * Full Zone Annunciation/Control - Digital Key Stations with Night Light provide complete system control, Zone status Display and built in speaker for audible indications.
- * Audible Touch Pad Annunciation.
- * Exit/Entry Delay - Programmable duration. Entry Warning Tone. Optional Exit Warning Tone.
- * Interior Touch Switch enables/disables Interior Zones. Option to disable switch when system is Armed.
- * Exterior Door Chime monitor when system is Disarmed with switch to enable/disable.
- * Follower Zone option for interior zone delay after an Entry delayed zone has been violated.
- * Instant Touch Switch - One touch switches Delayed Zones to Instant. Touch again and they will revert back to Delayed Zones.
- * Local Alarm Memory - Zones in Alarm will be displayed at the Digital Key Station even after Disarming system.
- * System Test initiated from Digital Key Station.
- * Optional Duress (ambush/holdup) Reporting.
- * Selectable Detection Delay times to accomodate different types of initiating devices.
- * Optional Mechanical Key instead of Digital Key Station.
- * Alarm Shutdown/Reset Time programmable from 10 to 2550 seconds(42.5 min)
- * Fast Reset Option (Zones can restore before Alarm Shutdown)
- * Automatic Repeat Alarm Shunting.
- * Built-In Automatic Battery Charge/Test circuit.
- * EEPROM Programming - Not subject to memory loss if power is removed. Allows reprogramming up to 1000 times.
- * Touch Tone or Rotary Dialing.
- * Several Reporting Formats available:
(Silent Knight, Sescoa, Radionics, Ademco)
- * Can Report to two phone numbers with same or different data.
- * Optional Intercom Capability.
- * Optional Local Alarm Zones when using the Model 2724.
- * Optional use of Model 5255 On-Site Printer.
- * Optional use of Models 1520L or 1522L Supervised RF Receivers.
- * 1.2 Amp Power Supply.
- * Latching Smoke Detectors may be Reset from the Digital Keystations.

CONTROL PANEL DESCRIPTION

Figure 1 represents the Model 2720 printed circuit board. This board contains the switches, fuses, electronic components and connectors needed to install, monitor and protect the system. The following paragraphs describe the major components of the system.

A.C. POWER TRANSFORMER

An external transformer (Model 9220 included) is used to supply 16.5 VAC (45VA) to power the system under normal conditions and to supply charging current to the backup battery. The primary of this transformer plugs directly into a conventional 115 VAC unswitched outlet. The secondary is wired into terminals 1 and 2 of the 2720 with a two conductor cable (preferably shielded).

BATTERY CABLES

The RED (+) and BLACK (-) Battery Cables are used to connect a 12 VDC battery (Silent Knight Model 6812) to the system. The battery provides backup power to the 2720 in the event of AC power interruptions.

CAUTION: Observe proper polarity when connecting the battery cables of the 2720. A bi-metal switch is mounted on the 2720 circuit board which will automatically remove battery power to the board in the event of reversed battery polarity.
(See power-up sequence -page 13-)

NOTE: The Model 6812 12V 4.5 AH battery will provide at least 4 hours of standby operation to the basic 2720 system. The use of accessories may reduce this time so that additional battery capacity may be needed.

FUSES

F1 is a 2-1/2 Amp Fuse which provides over-current protection for any accessories connected to terminal 6 of the 2720. F2 is a 1/2 Amp Slow Blow Fuse which provides over-current protection for the smoke detectors or any other accessories connected to terminal 16 of the 2720.

DC POWER SWITCH

The DC power switch is used to remove DC power from the circuitry of the 2720. The only thing that remains functional when this switch is in the OFF position is the battery charging circuit.

CONTROL EEPROM

The Control EEPROM (Electrically Erasable Programmable Read Only Memory) contains information that is used by the Control Microprocessor. This information determines what control options the system will perform. This information must be programmed into the EEPROM by using either the Model 5506 Desk Top Programmer or the Model 5510 Handheld Programmer. Refer to the programming section and the PROM Coding Forms for more information.

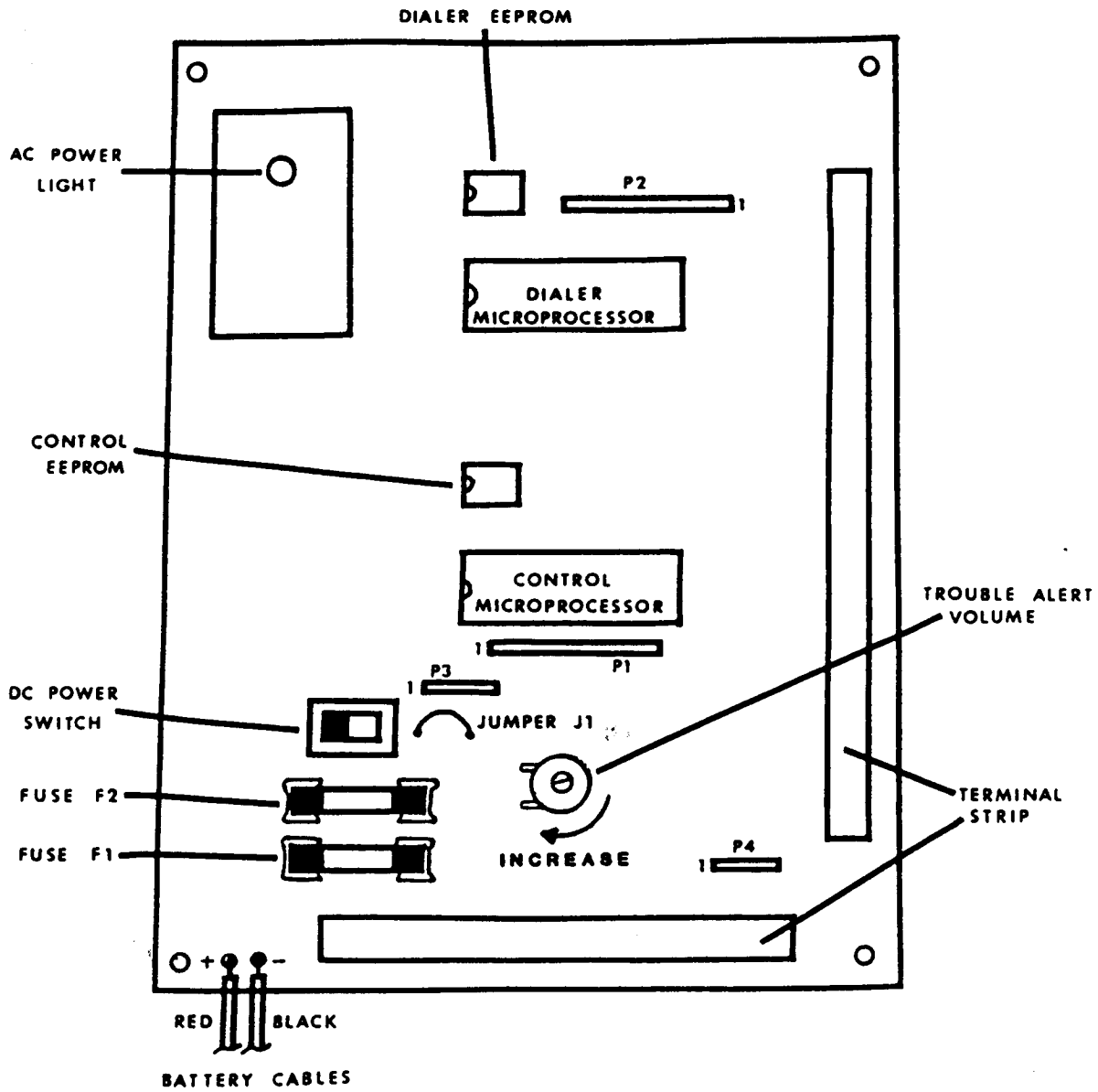

MODEL 2720 CIRCUIT BOARD

FIGURE 1

AC POWER LIGHT

This green LED is on whenever AC power is present, the DC power switch is in the ON position and the accessory power fuse (F1) is good.

DIALER EEPROM

The Dialer EEPROM contains information that is used by the Dialer Microprocessor. This information includes telephone numbers and dialer options which will be performed by the system. This information is programmed into the EEPROM using one of the Programmers mentioned on the previous page. Again, refer to the Programming section and the PROM Coding Forms for details.

CONNECTOR P1

Sixteen pin connector P1 is used to interface with the Silent Knight Models 1520L or 1522L Supervised RF Receivers. Refer to the Supervised RF Receiver Installation section of this manual.

CONNECTOR P4

Six pin connector P4 is used to interface with the Silent Knight Model 7361 Intercom Board. Refer to the 7361 Installation section of this manual.

TROUBLE ALERT VOLUME CONTROL

The Trouble Alert Volume Control is a potentiometer which controls the volume of the trouble alert and annunciator tones at the digital key stations. Rotate the control clockwise to increase the volume.

ACCESSORIES

The following accessories will be available for use with the Model 2720. Below is a brief description of each accessory and its function with respect to the Control Panel.

- * Model 6812 12 Volt 4.5AH Gell Cell Battery - Provides 4 hours standby power to the basic 2720 unit. Additional accessories will reduce this time.
- * Model 9220 16.5 VAC 45 VA Transformer - Supplied with the Model 2720. Provides AC power to the 2720 and accessories.
- * Model 2070 Digital Keystation - Provides complete system control. Contains indicators for zone and system status, keypad with 16 touch switches plus night light and built-in speaker for audible annunciation. Allows remote arming, disarming, zone shunting, system test and manual activation of emergency and fire alarms. You also program and enter up to 10 user access codes from the Model 2070.
- * A Mechanical Key can be installed to arm/disarm the system instead of the Model 2070 Digital Keystation. Refer to the accessory wiring section for more information.

ACCESSORIES (CONTINUED)

- * Model 2720 with Intercom Feature - A system consisting of the Model 2720, the Model 7361 Intercom Module and up to four (4) Model 2069 Keystations with Intercom capability (instead of the standard 2070 keystations), allows the keystations to talk and listen to a Model 7380 Speaker/Microphone so that the user can interrogate people at that outside speaker.
NOTE: The intercom cannot be used to talk/listen to the other keystations.
- * Model 2069 Digital Keystation - Provides all the features of the Model 2070 Digital Keystation but also performs as an Intercom Station. When using the Model 2069 Digital Keystations you must also use the Model 7361 Intercom Module which plugs directly into the 2720 circuit board.
- * Model 7361 Intercom - Provides Intercom capabilities to the systems Keystations. Must be used with Model 2069 Digital Keystations.
- * Model 1520L or Model 1522L Supervised RF Receivers - To receive transmissions from the Models 1501, 1502, 1503, 1504, 1505, 1506 RF Transmitters. The Supervised RF Receiver will connect to the Model 2720 through a prewired interconnect harness (shipped with receiver) which quickly plugs into the 2720 circuit board.
- * Model 7620 Smoke Detector - UL listed smoke detector for use with model 2720. Refer to zone wiring section.
- * Model 7140 Line Seizure Module - For use as a Ground Start Relay. To enable use of the 2720 with a ground start telephone trunk. Refer to accessory wiring section for more information.
- * Model 7171 Four Wire Loop Module - For use where a "Class A" fire zone is required. Allows for the detection of an alarm signal even after a single open or ground fault has occurred.
- * Model 7760 Low Current Electronic Siren with tamper proof enclosure - Provides local audible alarm annunciation.
- * Model 7040 Emergency Module - Provides additional Emergency and 24 hour Intrusion zone pushbuttons for manual alarm activation and annunciates all internal siren tones.
- * Model 7380 6" diameter white metal bezel with 8 Ohm speaker for use as intercom Speaker/Microphone when using Model 7361 Intercom Module and Model 2069 Digital Keystations.
- * Model 3500 Self Contained Alarm Control Panel. This inexpensive control may be used as a sub-control for "shopping mall" application if separate Exit and Entry delays are required for each protected area. (See special applications section.)
- * Model 5255 On-Site Printer - Provides a permanent record of all the Model 2720's activity. Enables you to reduce central station costs by minimizing the number of events reported.

PROGRAMMING

The Model 2720 provides a very wide variety of features which may be selected for use depending on your needs. These features are selected and then programmed into two EEPROM chips. The control panel comes with factory programmed EEPROMs as described on page 8. To "customize" installation the EEPROM (Electrically Erasable Programmable Read Only Memory) chips are programmed with either a Model 5506 Desk Top Programmer or a Model 5510 Hand Held Programmer. Both are quick and easy to use. You first mark all of the feature selections you want using the Prom Coding Forms included. Then you enter these selections into the programmer and finally program the EEPROMs. The EEPROM chips are 8 pin integrated circuit chips that can be reprogrammed up to 1000 times. Therefore, if you need to change or add an option you simply reprogram the EEPROM. Up to ten user access codes are programmed into the system directly from the Model 2070 Digital Keystation. Access codes can be changed or added by the user from the digital keystation. The Control EEPROM contains all the zone information and user access codes and the Dialer EEPROM contains all the telephone and account information. For specific information regarding features and options refer to the following sections:

- * Zone Features and Options
- * Programming Dialer Options
- * Reporting Formats
- * Prom Coding Forms
- * Programming User Access Codes

EEPROMS

The 2720 is shipped with two EEPROMs already inserted in their sockets on the printed circuit board. They must be removed and programmed one at a time before installation of the 2720 (See PROM removal paragraph) unless you wish to use the system as it was programmed at the factory.

The sockets of both programmers are designed to accept 16 pin IC's. It is important that the EEPROM is inserted in the correct half of the programmer socket (See Figure below). The notched end of the EEPROM chip should be on the far left side of the socket when correctly inserted in the programmer. When using the Model 5506 programmer, always use socket #1 to prevent damage to the EEPROM. After the EEPROM has been programmed, remove it from the programmer socket and reinsert it in it's socket on the 2720 printed circuit board (See Prom insertion paragraph).



PROM REMOVAL

To remove the EEPROM from it's socket on the PC Board, carefully pull straight out on the PROM puller (clear plastic loop). Save the PROM puller for re-use. If the loop is missing, use a small flat-blade screwdriver to gently lever the PROM out of it's socket. Slip the screwdriver under one end of the PROM and pry up slightly, then place the screwdriver under the other end and finish removal.

PROM INSERTION

To insert the PROM back into it's socket on the 2720 PC Board, place the plastic PROM puller between the two rows of pins on the PROM and carefully press the PROM with puller back into it's socket. Pay careful attention to which way the notched end of the PROM is facing. The notch should be on the LEFT side if the board is oriented as shown in Figure 1. Apply even pressure on each end of the PROM so that it goes in squarely. Check to make sure that all of the PROM pins are correctly inserted into the socket.

FACTORY PROGRAMMED EEPROMS

To facilitate testing and use without one of the programmers, each 2720 is shipped with pre-programmed EEPROMs which contain the following features. Zones 1-7 require the use of normally closed contact devices and EOL resistors. They are also shuntable zones. Zones 1 & 2 are Exit/Entry delay zones with exit delays of 1 minute and entry delays of 30 seconds. Zone 7 is an interior zone. Zone 8 is a 24 hour silent zone requiring normally open contact devices. Zone 8 is also NOT shuntable. All shunted zones will be reenabled when disarming. Swinger shunts and Duress reporting have been selected. Interior key is disabled when armed. Interior zone follower is selected. Shunt display is disabled when armed. Fire audible won't shutdown and codes 8 & 9 cannot arm/disarm the system. The system will make one dialing attempt per event. No telephone numbers were programmed.

PROGRAMMING USER ACCESS CODES

Programming user access codes is done directly from the Model 2070 keypad without the use of an additional programming device. First the 2720 must be in the program mode. Program mode is indicated by a flashing "Trouble Silent" light. Upon power-up the 2720 automatically enters the program mode. When the 2720 is already operating, you can enter the program mode by pressing "Shunt" then "Test" then enter User Access Code 0 (System must be disarmed with no shunted zones). Once the system is in the program mode you can program access codes by first entering the desired user access code (2-5 digits long, 1st digit unique for each code) then press "Test" after each code. Up to ten (10) user access codes can be programmed. Press "Shunt" to clear any errors in programming or wait for 5 seconds and the system will auto-clear. Press "Test" three (3) times to exit the program mode. The user access codes will be stored in the control EEPROM. This is non-volatile memory, so even after power is turned off and then on again, all access codes will remain operational. If no access code changes are required after the system is "powered-up", simply press the "TEST" key three times after turning the DC power switch to the ON position.

MODEL 2720 REPORTING FORMATS

The Silent Knight Model 2720 can transmit information in four different formats. The type of format you select is determined by the type of receiver used at the central station. The four formats are:

- * Silent Knight 3/1 - Old format, transmits a 3 digit account number and a 1 digit alarm code.
- * Sescoa 3/1 - Old format, transmits a 3 digit account number and a 1 digit alarm code.
- * Silent Knight 4/2 - Silent Knight expanded tone burst format, transmits a 4 digit account number and a 2 digit alarm code.
- * Silent Knight FSK - High speed, single round format for use with 8510/8520 receivers. 4 digit account number and 2 digit alarm code.

MODEL 2724 REPORTING FORMATS

The Model 2724 is identical in operation to the Model 2720 except for the reporting formats available. If you order the Model 2724 you can choose from the following two reporting formats:

- * Radionics BFSK - High speed format for use with Radionics receivers.
- * Ademco touch tone - High speed format for use with Ademco receivers.

The format you select is determined by the type of receiver used at the central station.

SILENT KNIGHT 3/1 AND SESCOA 3/1 FORMATS

These formats transmit a three digit account number and a single digit alarm code. These formats will greatly limit the information that can be reported. To avoid confusion at the central station, a standard alarm digit format should be decided upon. The user selects through programming what alarm digits will be reported for different events. You may select not to report restores or not to use zone numbers that might be duplicated by a supervisory transmission. Because these alarm digits are programmable, the following chart will refer to the appropriate step number on the PROM Coding Form rather than to define actual alarm digits.

SILENT KNIGHT FSK AND 4/2 FORMATS

The Silent Knight FSK and Silent Knight 4/2 formats transmit a four digit account number and a two digit alarm code as shown in the following chart. Also in the chart are the PROM Form step numbers where alarm digits are programmed for the Silent Knight 3/1 and Sescoa 3/1 formats.

<u>(FIXED)</u> <u>2-DIGIT</u> <u>EVENT</u> <u>CODE</u>	<u>SILENT KNIGHT FSK OR 4/2 FORMATS</u> <u>CODE DESCRIPTIONS</u>	<u>(PROGRAMMABLE)</u> <u>S.K. 3/1, SESCOA 3/1</u> <u>STEP # on PROM Form</u> <u>to select digit</u>
02	*1 FIRE ALARM	Step #1
03	*1 EMERGENCY ALARM	Step #2
09	DURESS	Step #10
11-18	*1 ZONES 1-8 RESPECTIVELY ARE IN ALARM	Steps #3 & #4
21-28	ZONES 1-8 RESPECTIVELY HAVE BEEN RESTORED	Step #6
30	DIALER TEST	Step #9
38	CANCEL	Step #9
40-49	ARMED BY USER # 0-9 RESPECTIVELY	Step #7
51-58	*1 ZONES 1-8 RESPECTIVELY HAVE BEEN SHUNTED	*2 Step #5
62	*1 FIRE ZONE TROUBLE	Step #5
63	*1 EMERGENCY ZONE TROUBLE	Step #5
69	*1 LOW BATTERY VOLTAGE	*2 Step #5
72	FIRE ZONE RESTORED	Step #6
73	EMERGENCY ZONE RESTORED	Step #6
79	BATTERY VOLTAGE RESTORED	Step #6
90-99	DISARMED BY USER # 0-9 RESPECTIVELY	Step #8

*1 - Optional memory reporting may be selected for these codes.

*2 - Indicates event that is reported as a trouble (Old Formats)

MODEL 2724 FORMATS

The Radionics BFSK format reports only digits 0-9. The Ademco touch tone format reports only channels 1-8. You select the digits (channels) you want reported for each alarm zone. Generally you will select the digits that the central station requires for each alarm zone. If it is desirable to have local alarm zones along with reporting zones, program a hex character, i.e. A, B, C, etc. into the programming step of the zone(s) selected to be local alarm only. Multiple inputs should not report the same digit (channel).

The chart on the following page lists what will be printed or displayed on a Radionics BFSK format and an Ademco Touch Tone format receiver, for each of the 2-digit codes. An "X" indicates a digit or value that is programmed by the user and therefore not defined here. For the sake of convenience, zone 3 is used as an example for all events shown in the Ademco column.

NOTE: ZONE 3 IS USED AS AN EXAMPLE FOR ALL EVENTS SHOWN IN THE ADEMCO COLUMN.

2-DIGIT EVENT CODE	RADIONICS BFSK FORMAT	ADEMCO TOUCH TONE FORMAT	
		CHANNEL 1234 5678	STATUS CH.
		channel 3 = zone example	
02	ALARM ZONE X	5515 5555	7
03	ALARM ZONE X	5515 5555	7
09	ALARM ZONE X	5515 5555	7
11-18	ALARM ZONE X	5515 5555	7
21-28	RESTORAL ZONE X	5535 5555	7 (restore from alarm)
30	RESTORAL ZONE 9	5555 5555	9
40-49	CLOSING ZONE Y, where Y= user ID number.	Y444 4444	4 where Y= user ID number
51-58 (shunts)	TROUBLE ZONE X WAS FORCE ARMED	5515 5555	3 (zone 3 shunted)
62-63	TROUBLE ZONE X	5515 5555	5
69	TROUBLE ZONE 9	5555 5555	8
72-73	RESTORAL ZONE X	5535 5555	5 (restore from trouble)
79	RESTORAL ZONE 9	5555 5555	9
81-88	not used	5535 5555	3 (restore from shunt)
90-99	OPENING ZONE Y, where Y= user ID number.	Y222 2222	2 where Y= user ID number

NOTE: The 2720 has 11 channels - 8 intrusion zones, 1 fire zone, 1 emergency and duress. Since the Radionics BFSK format only has 10 channels and the Ademco format only has 8 channels it will not be possible to use all the 2720 channels when using these formats.

2720 CONTROL PANEL INSTALLATION

1. SELECT A LOCATION

When selecting a location to mount the 2720 control panel consider the following factors. The unit should be mounted where it will not be exposed to extremes in temperature and it will be free from moisture. The panel should be accessible to "Main Drop" wiring runs. The 2720 should be located well within secured area but should be accessible for testing and service.

2. MOUNT THE 2720

Mount the 2720 so it is firmly secured to the wall surface. When mounting on concrete, especially when moisture is expected, attach a piece of 3/4 inch plywood to the concrete surface and then attach the 2720. Mount any other desired components (such as an optional 7140 module) to the plywood interface.

3. INSTALL THE 9220 POWER TRANSFORMER

Figure 2 shows the connection of shielded 2-conductor cable and the Model 7890 Transient-Surge Protector to the Model 9220 UL Listed Class II Power Transformer (16.5 VAC 45VA). Both Models are included with the 2720. The transformer should be plugged into a 120 VAC 60 Hz. continuous duty (unswitched) grounded outlet.

WARNING: The Model 9220 contains an internally fused secondary winding. DO NOT SHORT the secondary terminals together when power is applied or the internal fuse will blow. Be sure the shield conductor can not come in contact with the AC output screws.

The Model 7890 Transient-Surge Protector will protectively clamp the AC output of the transformer, reducing transient voltages caused by lightning and other sources. The AC power lines are the most common source of transient/lightning damage in alarm systems. The Model 7890 consists of 2 bipolar transient suppressors with lugs at its connecting points.

CAUTION: Insure that the AC outlet you intend to use for the Model 9220 plug-in transformer has a "good" connection to earth ground. This can be done at the outlet, using a digital voltmeter, by measuring the AC voltage between the "hot" side of the outlet and neutral, then comparing that voltage to the voltage reading made between the "hot" side and the ground connection. The difference between these two voltage readings should not exceed .2 VAC. If these voltages are not within .2 VAC the outlet does not have an earth ground and must be grounded by running a 14 gauge wire from the outlet to a good source for earth ground.

NOTE: - A licensed electrician may be required to perform this procedure.

CAUTION: To reduce the risk of fire or electrical shock, connect directly to a grounded (3-prong) receptacle.

4. CONNECT ALL INITIATING DEVICES AND ACCESSORIES

Connect all initiating devices and accessories to the 2720 terminal strips before connecting AC or DC power to the panel. Use the wiring diagram in Figure 11 and the terminal strip description as a guide.

5. CONNECT POWER TO THE 2720

Make sure the EEPROMs have been programmed and reinstalled into the 2720 circuit board before continuing (see programming section). Once all the connections have been made to the Model 2720 and associated equipment, double check them against the installation manual. When they are confirmed to be correct, the system may be powered up in the following sequence.

- a. DC power switch in the OFF position.
- b. Connect the battery cables to the 12 VDC Gell Cell battery.
- c. Turn the DC power switch ON.
- d. Attempt to program the control panel using the Model 2070 keystation.
- e. Take the recommended action according to the following responses:
 1. If the system does program properly, proceed to connect the 16.5 VAC transformer.
 2. If the system does not operate, check for the following possible problems:
 - * A dead Gell Cell battery.
 - * Poor battery connections.
 - * Reverse polarity battery connections.
 - * Blown fuses

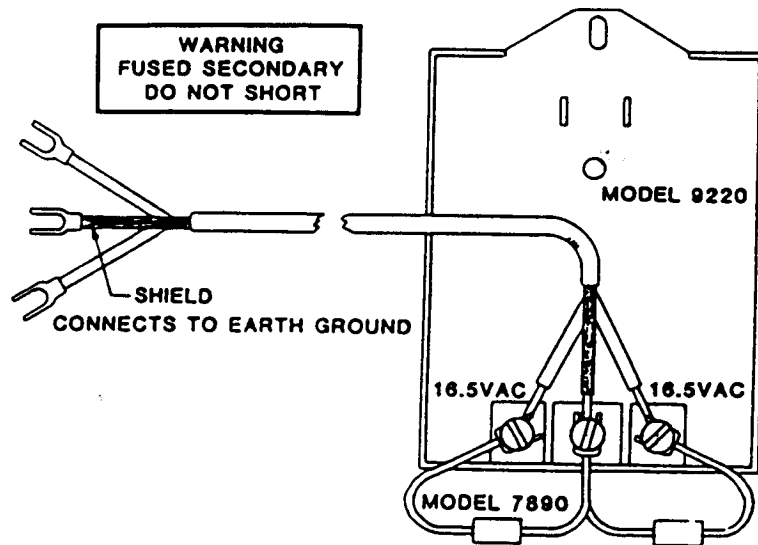

MODEL 9220 TRANSFORMER

FIGURE 2

ZONE FEATURES AND OPTIONS

The Model 2720 contains inputs for 8 intrusion zones, 1 supervised fire zone and 1 supervised emergency input. The following is a list of features which are individually programmed for each of the 8 intrusion zones.

- * EOL Zones - You must use an End-Of-Line resistor in zones that employ any normally closed initiating devices. You may use an EOL resistor in zones that use only normally open contact devices. In these zones, a break in the loop or closed contacts will cause an alarm. When you use an EOL resistor you must also program that zone as an EOL zone. Refer to Figure 3.
- * Fast Zones - Allows the use of fast acting sensors without the use of a "pulse stretcher". Select for 5 msec. or 100 msec.
- * Slow Zones - Select for zones requiring detection delay of 100ms, 1 second 10 seconds or 60 seconds as selected in step 12 of the Prom Coding Form. Different types of sensors require different detection delays. Selecting slow detection avoids possible false alarms due to poor contacts or RF transients.
- * 24 Hour Zones - Select for zones that will initiate an alarm signal even when the system is disarmed (panic, tamper, auxilliary).
- * Silent Zones - Select for zones that will not cause a local audible alarm indication. They will still report the alarm.
- * Entry/Exit Delay - Select for zones that will not cause an immediate alarm when violated. These zones will allow the user to enter/exit for disarming/arming the system. An entry tone will sound during entry delay. An optional exit tone can be selected in step 13.5 of the Prom Form.
- * Interior Zones - Select for interior zones. Interior switch allows enabling/disabling of interior zones, or zones to be shunted as a group. The option to have interior switch disabled when armed is selected in step 14.1 of the Prom Form. Interior zones are always exit delayed and will optionally operate as "follower zones". This option is selected in step 14.2 of the control PROM Form.
- * Shunable Zones - Select for zones that you want shunable. If not selected for a zone, you will not be able to shunt that zone.

The following is a list of programmed options and timing selections.

- * Shutdown Time - Selectable in increments of 10 seconds. Range from 10 seconds to 42.5 minutes. Controls how long after an alarm the audible indication will sound.

- * Exit Delay Time - Selectable in increments of 10 seconds. Range from 10 seconds to 60 seconds. Affects only those zones selected for Entry/Exit delay. Exit delay is the time you have to leave a zone after arming without causing an alarm.
- * Exit Tone - Option to sound a tone pattern during the exit delay time. This includes a distinct tone pattern during the 8 seconds just before exit time expiration.
- * Entry Delay Time - Selectable in increments of 10 seconds. Range from 10 seconds to 40 seconds. Affects only those zones selected for Entry/Exit delay. Entry delay is the time you have to disarm the system after you have violated an Entry/Exit zone before causing an alarm. A tone pattern will sound during the entry delay time.
- * Fast Zone Detection Time - Selectable as either 5ms or 100ms. Affects all zones not selected as slow. It is the time it takes the system to detect an alarm.
- * Slow Zone Detection Time - Selectable as either 100ms, 1 second, 10 seconds or 60 seconds. Affects all zones selected as slow. It is the time it takes the system to verify an alarm signal. Slow Zones will not be in alarm until a signal is present at the zone input for at least this long.
- * Force Arm - Option to enable force arming. When you attempt to arm the system and some zones are not ready, the system will automatically shunt the zones not ready and system will arm.
NOTE: Force Arming will shunt any "not-ready" zones, even if they are programmed as not shuntable in step 7.
- * Auto Unshunt at Disarm - Option to allow all shunted zones to automatically unshunt when system is disarmed.
- * Swinger Shunt - Select this option to enable the system to automatically shunt a zone that has reported four separate consecutive alarms within a four hour period. The system will report a shunt rather than an alarm after the fourth occurrence.
- * Fast Restore - This option enables the system to detect new events before shutdown time has elapsed.
- * Bell Test at Arming - Selecting this option will cause the 2720 to sound a brief bell test whenever system is armed.
- * Mechanical Key - Select this option when you wish to use a mechanical key to arm/disarm system instead of the Model 2070 or 2069 Digital Keystations.
- * Duress - This option allows a report to be sent to the central station when forced to disarm the system. No indication of alarm or reporting is made at digital keystation.

- * Interior Zone Follower - Option allows interior zones to be ENTRY DELAYED if a perimeter zone selected for ENTRY/EXIT delay is violated first. Allows user to disarm at keystation located in an interior zone.
- * Shunt Display Disabled When Armed - Option, zone LEDs won't display shunted zones when system is armed.
- * Fire Audible Won't Shutdown - Won't allow fire alarm audible indication to be silenced without disarming. This is required by some local Fire Marshals.
- * Silent Emergency Alarm - Option to make the emergency alarm silent for use with panic switches etc..
- * Codes 1-8 Only Shunt One Zone - Would be selected for use in a commercial installation where each access code 1-8 would be used to shunt the corresponding zone. For example, code 4 could only shunt zone 4.
- * Codes 8 and 9 Cannot Disarm - Option to remove the disarming capability from access codes 8 and 9.
- * Codes 1-9 Cannot Arm or Disarm - Option which allows only access code 0 to arm or disarm the system. To be used in a commercial installation in conjunction with "Codes 1-8 only shunt one zone".

ZONE WIRING AND PROGRAMMING

The zones of the Model 2720 can be wired in three basic ways. These three ways are illustrated in Figure 3. Combining these basic zone wiring methods with the various zone programming options, results in a great variety of possible zone configurations. It is recommended that you bench test any configurations before you install the control panel.

NOTE: In UL certified installations an End-Of-Line resistor must be used with each zone as illustrated in Figures 3b and 3c. The wiring diagram in Figure 3a is not acceptable for UL certified installations.

1.END-OF-LINE RESISTORS

An EOL resistor **MUST** be used with any intrusion zone using a normally closed initiating device. If you wish, you **MAY** use an EOL resistor with intrusion zones using only normally open initiating devices. (If no EOL is used, the installation will not be acceptable for UL certification.) If you use an EOL, a break in the loop or closed contacts will cause an alarm. An intrusion zone using both normally open and normally closed initiating devices **MUST** use an EOL resistor. Any intrusion zone using an EOL resistor must also be programmed as an EOL zone. The End-Of-Line resistors are Silent Knight Model 7630, 15K Ohm resistors. Refer to Figure 3.

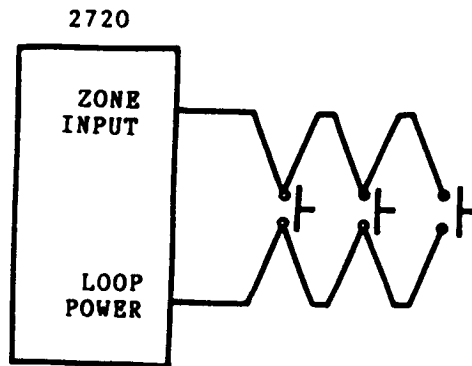

a) Unsupervised Intrusion Zone - using Normally Open contact initiating devices only and no End-Of-Line resistor. NOT ACCEPTABLE FOR UL INSTALLATIONS.

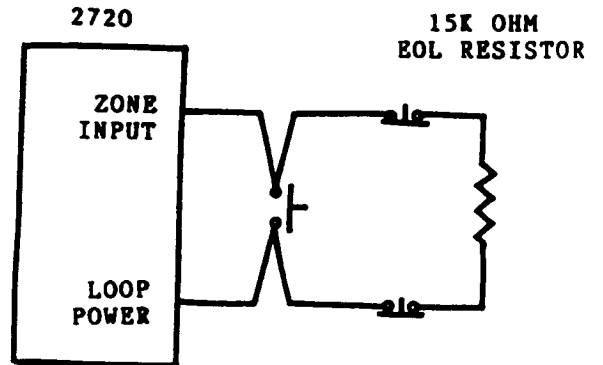

b) Intrusion Zone - using both Normally Open and Normally Closed initiating devices and an End-Of-Line resistor. The Normally Closed and the Normally Open contacts will be supervised; i.e. - an alarm will occur if the loop is crossed or broken.

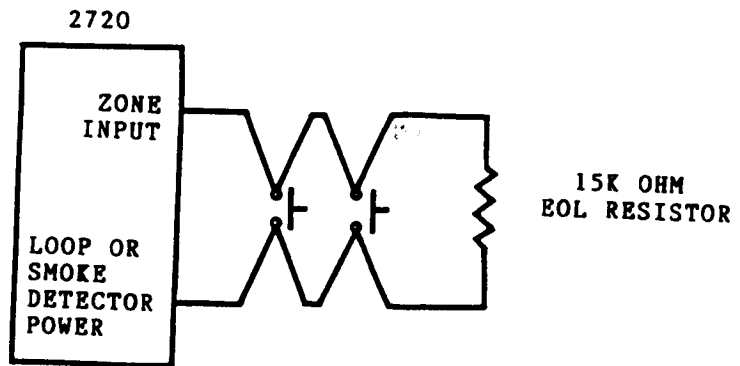

c) Supervised Fire, Intrusion or Emergency Zones - using Normally Open contact initiating devices only and an End-Of-Line resistor.

FIGURE 3

MODEL 2720 ZONE WIRING

2.ZONE CONFIGURATION EXAMPLE

In the following chart, sample configurations are described. Then, the following paragraph shows a section of the Prom Coding Form with zones circled to match the sample configurations. If the PROM is programmed as shown on this section of the PROM Coding form, the 2720 will function as described in the example (Remember, this is only an example).

- * ZONE 1 - Intrusion zone using normally open contact devices. Not shuntable.
- * ZONE 2 - Intrusion zone using both normally open and normally closed contact devices and an End-Of-Line resistor. Not shuntable.
- * ZONE 3 - Intrusion zone with slow detection time. Shuntable. N.O. contacts
- * ZONE 4 - Tamper detection. Active 24 hours a day. Not shuntable. N.O. contacts.
- * ZONE 5 - Intrusion zone, exit/entry delayed. Shuntable. N.O. contacts.
- * ZONE 6 - Interior zone using normally closed contact devices. Shuntable.
- * ZONE 7 - Intrusion zone, active 24 hours a day with slow detection time and silent alarm. Shuntable. N.O. contacts.
- * ZONE 8 - Intrusion zone, exit/entry delayed with silent alarm. Shuntable. N.O. contacts.

NOTE: The Fire and Emergency zones are always supervised, End-Of-Line, 24 hour zones using Normally Open contact devices only. The only programming options for these zones are in Step 14.4 "Fire Audible Alarm won't shutdown" and step 14.5 "Silent Emergency Alarm".

3.PROGRAMMING ZONE CONFIGURATION EXAMPLE

The previous zone configuration examples would be programmed as illustrated by this section of the PROM Coding Form.

STEP #	DESCRIPTION	CIRCLE APPROPRIATE ZONES
1.	End-Of-Line Zones	1 ② 3 4 5 ⑥ 7 8
2.	Slow Detection Zones	1 2 ③ 4 5 6 ⑦ 8
3.	24 Hour Zones	1 2 3 ④ 5 6 ⑦ 8
4.	Silent Alarm Zones	1 2 3 4 5 6 ⑦ ⑧
5.	Exit/Entry Delayed Zones	1 2 3 4 ⑤ 6 7 ⑧
6.	Interior Zones	1 2 3 4 5 ⑥ 7 8
7.	Shuntable Zones	1 2 ③ 4 ⑤ ⑥ ⑦ ⑧

4. MODEL 7620 SMOKE DETECTOR

The Model 7620 Smoke Detector can be used when wiring the fire zone of the Model 2720. Figure 4 illustrates how it should be wired. The Model 7620 Smoke Detector is rated at 50 uA. in the normal supervisory condition and 15 mA. in the alarm condition. A maximum of thirty (30) 7620's may be used with the 2720 Control Panel.

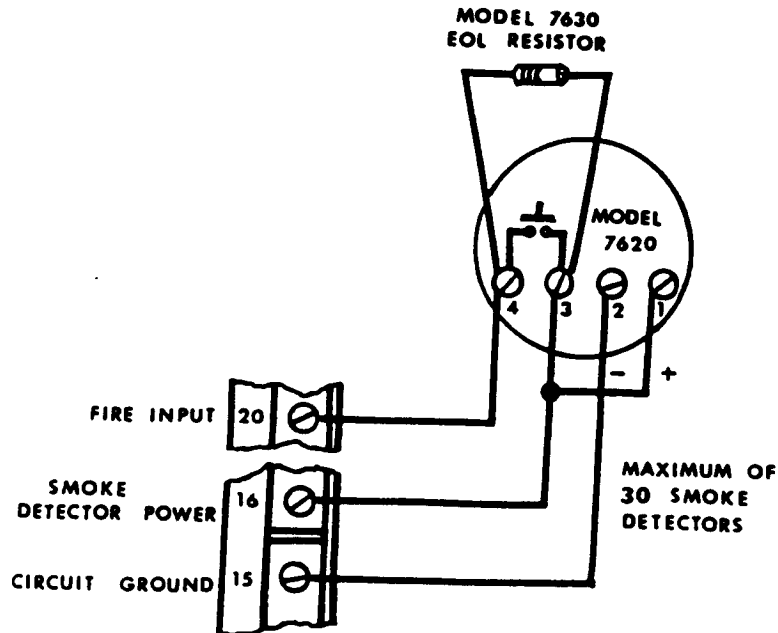

FIGURE 4

5. EMERGENCY ZONE WIRING

Figure 5 is a typical wiring diagram of an emergency zone using panic switches. The zone is supervised and employs only normally open initiating devices and an End-Of-Line resistor.

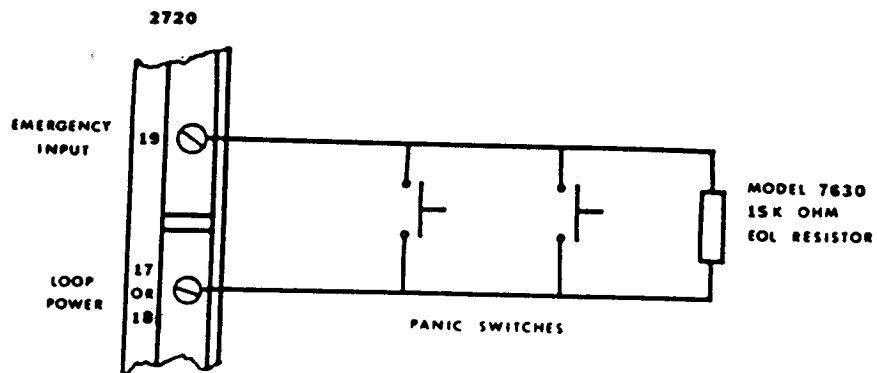

FIGURE 5

PROGRAMMING DIALER OPTIONS

The Model 2720 and the Model 2724 each have their own Dialer Chip PROM Coding Form. Refer to the appropriate form for details on programming dialer options. Each form allows you to select reporting channels for use with older formats that report single digit alarm codes. You also select such options as:

- * Number of attempts before switching phone numbers.
- * Total number of attempts.
- * Rotary or Touch Tone dialing.
- * Ground start.
- * Reporting format and acknowledge tone.
- * Events which will be reported.
- * Account numbers.
- * Telephone numbers.

ACCESSORY WIRING

1. EXTERNAL ALARM BELL OR SIREN

Figure 6 shows the wiring of an external alarm bell. You may also use a Model 7760 Electronic Siren. If you use a bell you must install the supplied transient suppressor, Model 7800, as close as possible to the bell contacts. If you use the electronic siren you do not need to install the transient suppressor. It may be desirable to disable the alarm tones at the digital keystations when you are using an external alarm bell or siren. To accomplish this, simply cut jumper J1 on the Model 2720 circuit board. The digital keystations will still emit all the low volume audio indications.

- NOTE:** 1. In UL certified installations an external alarm bell must be enclosed in a UL listed cabinet with tamper switches.
2. CSFM listed systems require one (1) listed audible driver to be installed inside residence.

MODEL 2720

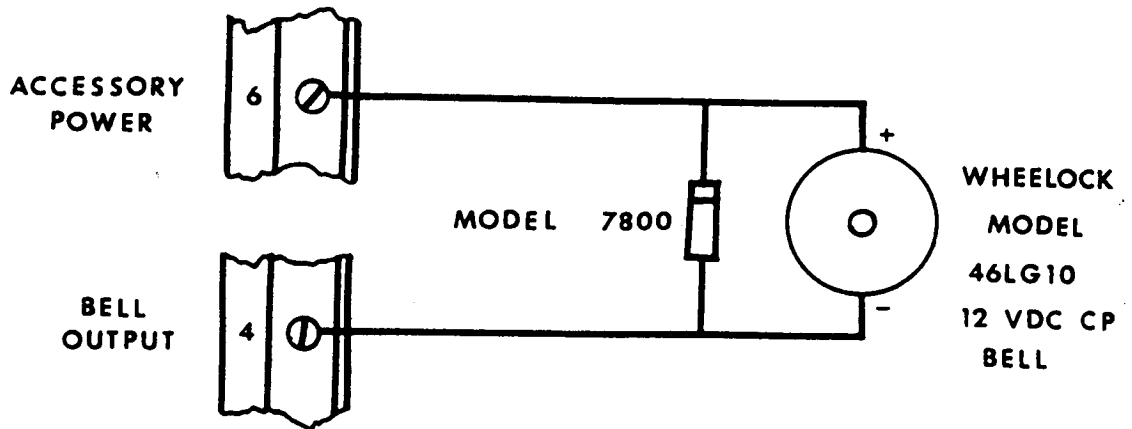
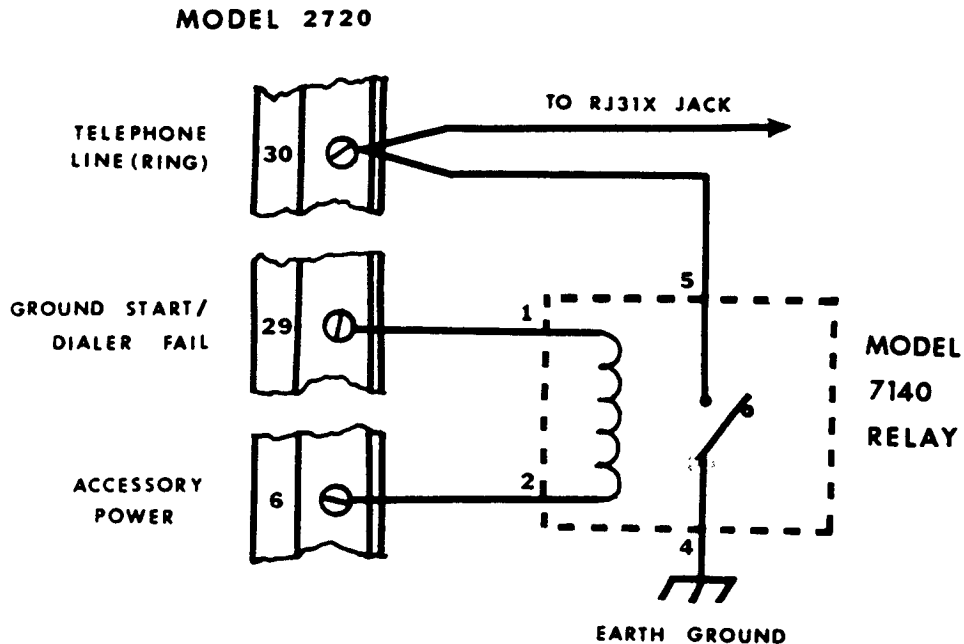

FIGURE 6

2. GROUND START RELAY

The Model 2720 normally communicates to the Central Reporting Station over standard "Loop Start" telephone networks. In some instances, it may be necessary to communicate over "Ground Start" telephone networks. Ground Start networks require a momentary connection between one side of the telephone line and earth ground to enable dial tone. The Model 2720 will accommodate Ground Start trunks with the addition of a 12 VDC relay. Figure 7 shows the wiring of the Ground Start relay. If you use the Ground Start feature you must select it when programming the dialer EEPROM. If you use the Ground Start feature you may not use a dialer failed indicator.

NOTE: In UL certified installations you may not use a ground start telephone network because it cannot be supervised.



3. EXTERNAL DIALER FAILED INDICATOR

A 12 VDC device such as an indicator lamp or the coil of a relay may be wired as a dialer failed indicator, provided you are not using the Ground Start feature. Figure 8 shows how to wire the device so it will activate whenever the unit fails to communicate with the Central Station within the selected number of attempts.

NOTE: In UL certified installations a "Dialer Failed Indicator" must be used.

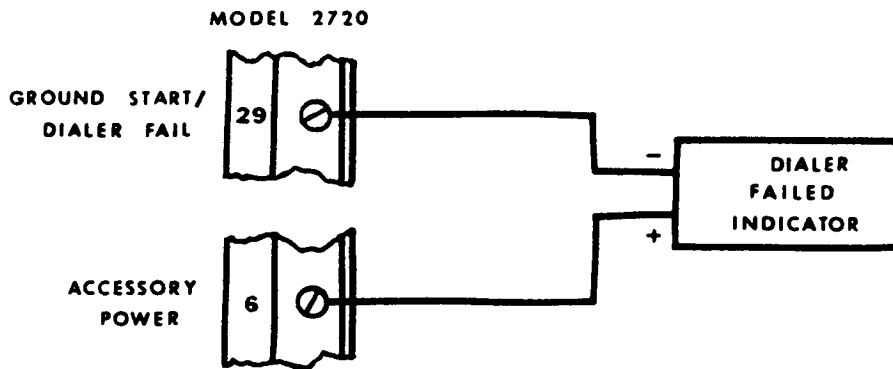

FIGURE 8

4. TELEPHONE LINE WIRING

The Model 2720 communicates to the Central Station over the same telephone line already installed in your home or building. You should connect the 2720 to the phone line using an RJ31X type phone jack. The telephone company will install an RJ31X jack upon request. The Model 7860 connecting cord will mate to the RJ31X and can be wired into the 2720 as shown in Figure 9.

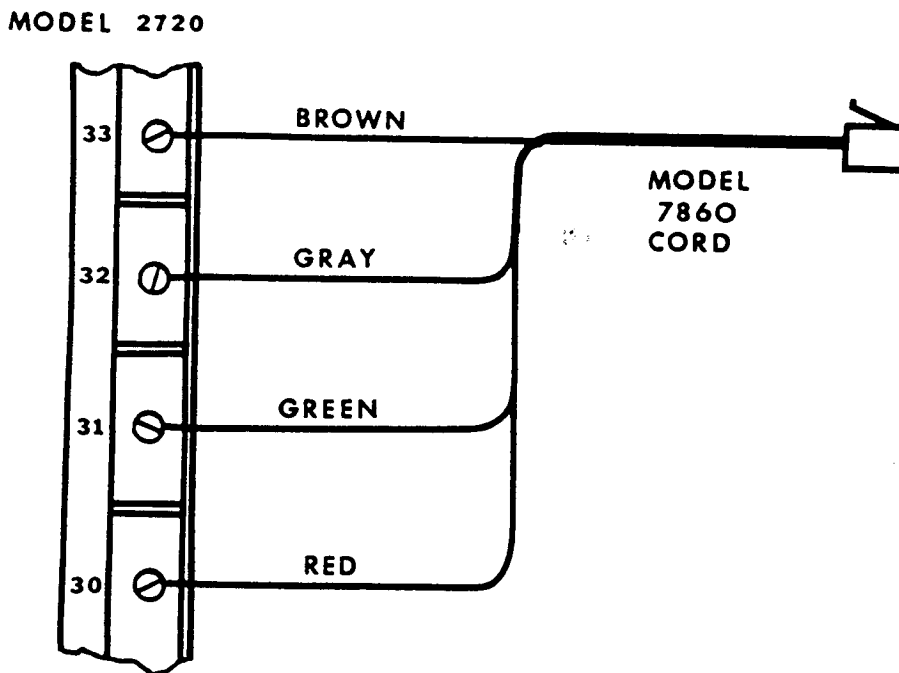

FIGURE 9

5. MECHANICAL KEY FOR ARMING/DISARMING

Figure 10 illustrates how to wire a momentary contact Mechanical Key switch to the 2720 for arming and disarming the system. The mechanical key switch is used instead of the digital keystations. It may NOT be used along with digital keystations. You must select Step 13.7 on the control PROM form.

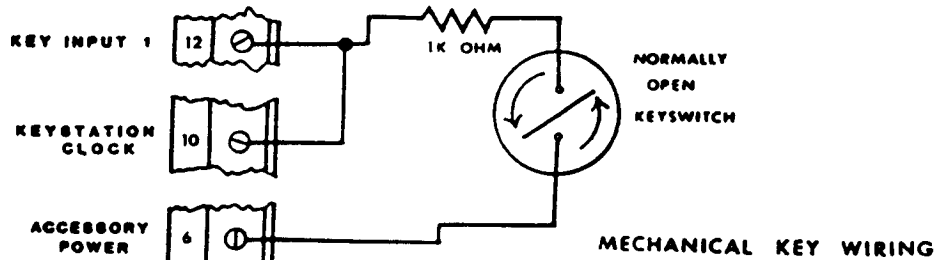

FIGURE 10

6. MODEL 2070 DIGITAL KEYSTATION WIRING

The Model 2070 Digital Keystations are wired as listed in the following chart. Installation requires the use of a 10 conductor cable from each keystation to the 2720 control panel. Each keystation includes a short pigtail cable which may be unplugged to simplify installation or replacement. You must orient the pigtail cable so that it's wires are leading over the circuit board, when plugged in. Refer to the Digital Keystation Installation and Operation sections for more information about the 2070. The pigtail cable should be wired as follows:

2720 TERMINAL NUMBER	WIRE COLOR	FUNCTION
* 14	* BROWN	* KEY INPUT 3
13	RED	KEY INPUT 2
12	ORANGE	KEY INPUT 1
11	YELLOW	KEY INPUT 0
10	GREEN	KEYSTATION CLOCK
9	BLUE	KEYSTATION DATA
8	VIOLET	KEYSTATION ENABLE
7	GRAY	AUDIO
6	WHITE	ACCESSORY POWER +12 VDC
5	BLACK	CIRCUIT GROUND

* In some instances it may be desirable to install one or more keystations outside of a protected premises. In these cases, you would want to disable the Fire, Emergency, Instant and Interior keystitches. To accomplish this simply do NOT connect KEY INPUT 3 (Brown) to terminal 14 on the 2720.

7. MODEL 2069 KEYSTATION WIRING

Refer to the Model 2720 Intercom Section of this manual for wiring diagram.

8. MODEL 7040 EMERGENCY MODULE

The Model 7040 Emergency Module provides additional emergency and 24 hour intrusion zone pushbuttons for manual alarm activation. The Model 7040 also contains an internal speaker for all alarm tones. The diagram in Figure 11 shows how to install the Model 7040 to the Model 2720.

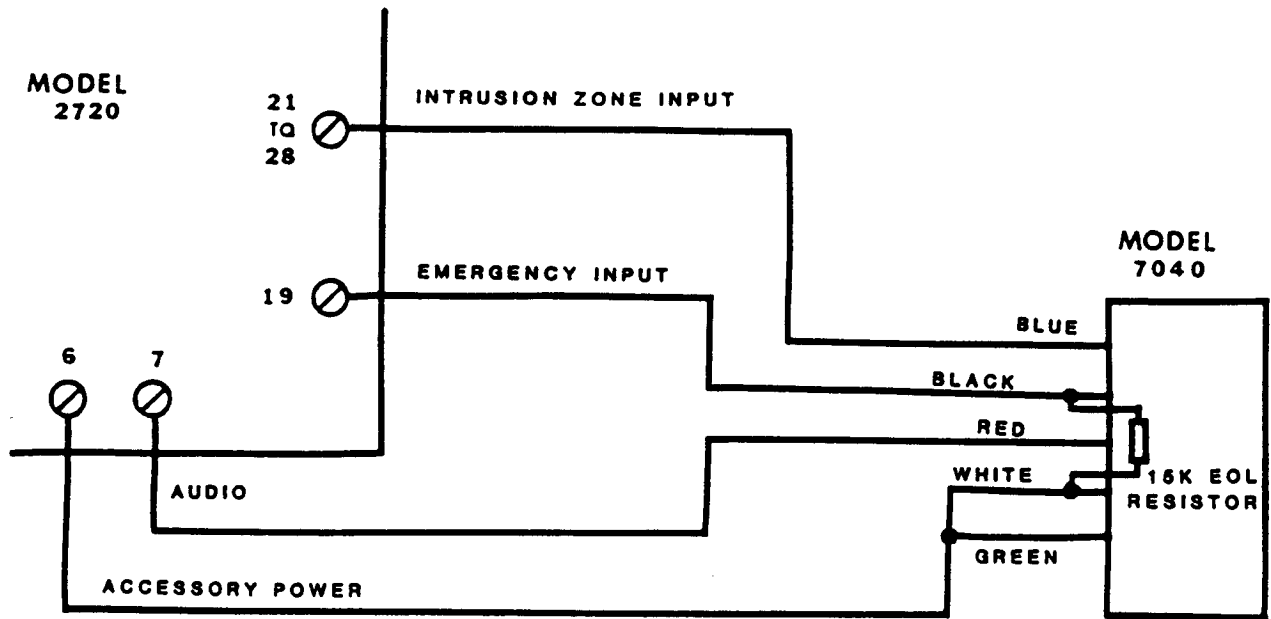

FIGURE 11

MODEL 7040 WIRING DIAGRAM

TERMINAL STRIP DESCRIPTION

<u>TERMINAL NUMBER</u>	<u>DESCRIPTION</u>
1	- 16.5 VAC 60 Hz. (45VA)
2	- 16.5 VAC 60 Hz.
3	- Earth Ground
4	- External Alarm Bell, 350 mA max.
5	- Common Negative (Circuit Ground)
6	- Accessory Power, +12 VDC, 2.25A max *1 (fused at 2.5A)
7	- Audio (to 2070 keystation)
8	- Keystation Enable
9	- Keystation Data
10	- Keystation Clock
11	- Key Input 0
12	- Key Input 1
13	- Key Input 2
14	- Key Input 3
15	- Common Negative (Circuit Ground)
16	- Smoke Detector Power, +12 VDC, 0.4A max (fused at 0.5A) *2
17	- Loop Power, +12 VDC, 50 mA max. (current limited)
18	- Loop Power, +12 VDC, 50 mA max. (current limited)
19	- Emergency Zone Input
20	- Fire Zone Input
21	- Zone 1 Input
22	- Zone 2 Input
23	- Zone 3 Input
24	- Zone 4 Input
25	- Zone 5 Input
26	- Zone 6 Input
27	- Zone 7 Input
28	- Zone 8 Input
29	- Ground Start/Dialer Failed Output, 100 mA max.
30	- Telephone Company line (TIP)
31	- Telephone Company line (RING)
32	- Telephone House line (TIP)
33	- Telephone House line (RING)

*1 NOTE: The sum of the current ratings of all 12 VDC accessories connected to Terminal 6 must not exceed 2.25A.

*2 NOTE: The maximum number of Model 7620 smoke detectors allowed per control panel is 30.

MODEL 2070 DIGITAL KEYSTATION

The Model 2070 (or Model 2069) is used to control all the system functions and contains system status lights and built-in speaker for audible indications. Most of the LEDS on the keystation are encoded to indicate more than one condition. For example, when the "READY" light is ON steady, the intrusion zones are all secure, but when the "READY" light is FLASHING, it indicates that the system is communicating. The following list explains what each light indicates and also describes the audible indications. Refer to Figure 13 for drawing of 2070 keystation.

- ZONE STATUS LED'S 1-8 - LED OFF indicates normal condition
LED ON indicates a bad zone
LED FLASHING SLOW indicates a shunted zone
LED FLASHING FAST indicates a zone was/is in alarm
- FIRE LED - LED OFF indicates normal condition
LED ON indicates trouble condition
LED FLASHING indicates fire alarm
- EMERGENCY LED - LED OFF indicates normal condition
LED ON indicates trouble condition
LED FLASHING indicates emergency alarm
- TROUBLE SILENT LED - LED OFF indicates normal condition
LED ON indicates a trouble has been silenced
LED FLASHING indicates system is in program mode
- READY LED - LED OFF indicates system armed or bad zone(s)
LED ON indicates system disarmed and all zones are either good or shunted or bypassed by interior switch
LED FLASHING indicates system is communicating
- ARMED LED - LED OFF indicates controlled zones are disarmed
LED ON indicates controlled zones are armed
LED FLASHING indicates system is in alarm
- INSTANT LED - -Instant LED toggled by Instant Key-
LED OFF indicates that the delay for Exit/Entry delayed zones is enabled
LED ON indicates that all Exit/Entry delayed zones are now instant (delay disabled)
- DOOR CHIME/INTERIOR LED -toggled by Door Chime/Interior Key-
- SYSTEM ARMED - LED OFF indicates Interior zones are disabled
LED ON indicates Interior zones are enabled
- SYSTEM DISARMED - LED OFF indicates the Door Chime feature is disabled
LED ON indicates the Door Chime feature is enabled
-opened or closed sensor in a perimeter zone will cause a chime at the keystation-

NIGHT LIGHT -

DIMLY LIT when in normal standby condition
BRIGHTLY LIT when keypad in use and during entry delay time (light will go dim 5 seconds after last key is pressed)

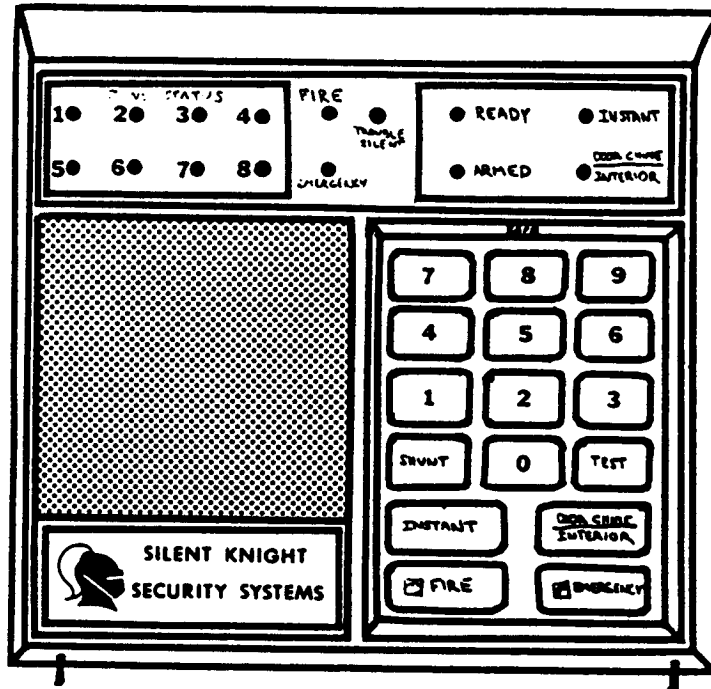

MODEL 2070 DIGITAL KEYSTATION

FIGURE 13

BUILT-IN SPEAKER - The keystations built-in speaker gives audible indications of alarms, troubles, exit/entry warning tones and a short "beep" whenever a key is pressed. The speaker is also used for the optional intercom feature (refer to Intercom section). All low volume audible indications may be adjusted using the trouble alert volume control (See Figure 1). This control does not affect the high volume alarm tones. The following is a short description of each audible indication.

Fire Alarm - High volume, high pitch intermittant tone.

Emergency Alarm - High volume, low pitch intermittant tone.

Intrusion Alarm - High volume, alternating high/low pitch constant tone.

Trouble Condition - Low volume, high pitch tone sounds for 1 second every 10 seconds.

Exit Tone - Low volume, low pitch intermittent tone.
(beep-beep-----beep-beep...)
Last 8 seconds of exit tone changes to rapid intermittent tone (beep-beep-beep-beep...)

Entry Tone - Low volume, alternating high/low pitch intermittent tone.
(deedle-deedle-----deedle-deedle-----deedle-deedle...)

Door Chime - Low volume, high to low pitch tone similar to a doorbell. Sounds once each time a perimeter zone sensor is opened or closed.

Key "Beep" Response - Short, low volume "beep" that sounds each time you press a key on the keypad.

SYSTEM OPERATION

System operating instructions that are not covered elsewhere in this manual are briefly described in the following paragraphs. A detailed description of system operation is found in the 2720 operation manual.

1. To Arm the System - Enter your access code.
2. To Disarm the System - Enter your access code.
3. To Shunt or Unshunt a Zone - Press the "SHUNT" key. Press the zone number you wish to shunt/unshunt (one zone at a time). If you don't hear a long beep, enter your access code.
4. To Silence a Trouble - Press the "SHUNT" key. Press the "0" key. Enter your access code. Once the trouble condition has been corrected, the appropriate zone LED and "TROUBLE SILENT" LED will turn off.
5. To Manually Activate Fire or Emergency Alarm - Press the "FIRE" or "EMERGENCY" key and hold it down for 1 FULL SECOND.
6. To Test the Communicator - Press the "TEST" key. Enter the 0 access code.
NOTE: The system must be disarmed to test.
7. To Activate Duress when Disarming - Press the "9" key. Enter your access code.
8. To Enter Program Mode - (there are two different methods)
 - a. Press "SHUNT" key, Press "TEST" key, then enter code 0.
(System must be disarmed and no zones shunted).
 - b. System will be in the program mode when it is first powered up.
(Turn system off and then on again)
9. To Change Access Codes - Enter program mode. Enter the codes to be changed. Press "TEST" key after each code. Press "SHUNT" key to clear any errors. Press "TEST" key three times to exit program mode.

Model 2720 With Model 2068 Keystation

The Model 2068 is a simplified keystation designed for commercial use. It is used for arming/disarming or programming the user codes on the 2720/communicator. It may be used by itself or in conjunction with the Model 2069 or 2070 keystations where either a full function key station is not required, or its location makes it susceptible to unauthorized use. The 2068 is wired the same as the 2070 keystation (See next section).

When the 2068 is used in conjunction with a 2069 or 2070, all system functions may be accomplished on the full function keystations. Because the 2068 is a limited function keystation, certain operating and programming functions will be altered slightly or omitted, if the 2068 is used by itself. To go back into program mode, it will be necessary to go to the 2720 control and switch the DC power switch off, then back on.

When programming the 2720 control chip, on systems using only the 2068 keypad, it will be necessary to omit the following steps since there will be no way to access them. The steps that should not be programmed are: 6, 7, 13.1, 13.2, 13.3, 14.1, 14.2, 14.3, 14.6, 14.8. The arm/disarm function and programming of user codes functions are the same as the 2070 keystation

DIGITAL KEYSTATION INSTALLATION

The Model 2070 or 2069 keystation attaches to the supplied bracket which may be mounted to a double-gang electrical box or directly to a wall surface using the appropriate fasteners. Mount the bracket with the longer tabs down. Pull the wires, from the 2720 through the center opening of the bracket and splice the wires to the supplied pig-tail cable using type B low voltage wire connectors. Slip the 2070 over the bracket's upper tabs and carefully rotate the 2070 down until the entire keystation is flush with the wall. Using a 1/16" Hex Key wrench (Xcelite Model LN-21 or equivalent), tighten the two set screws on the bottom of the 2070 until it is secured to the bracket. Refer to Figure 14 for this procedure. **NOTE:** A maximum of four (4) 2070 keystations may be used per 2720 control panel under normal conditions. Two additional 2070's can be used if their speakers are disabled (cut speaker wire).

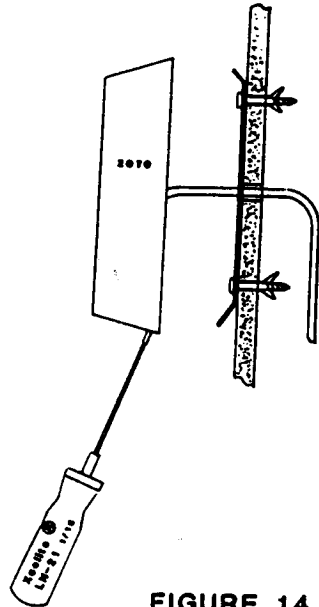

FIGURE 14

MODEL 2720 WITH INTERCOM

A system consisting of the Model 2720, (1) Model 7361 Intercom Module and up to four (4) Model 2069 Digital Keystations allows the keystations to talk and listen-in to a Model 7380 Speaker/Microphone. This enables the user to interrogate people at that outside speaker.

NOTE: The Intercom cannot be used to talk/listen to other Keystations.

The Model 7361 Intercom Module plugs into connector P4 on the Model 2720 circuit board. Refer to Figure 14 for a wiring diagram of the Intercom System.

The Model 2069 Digital Keystation is identical to the Model 2070 keystation with the exception of one keyswitch. The Model 2069 has an additional key labeled "INTERCOM" located between the "INSTANT" key and the "DOOR CHIME/INTERIOR" key.

INTERCOM OPERATION

All the operating features of the Model 2069 Keystation are identical to the Model 2070 Keystation with the exception of the Intercom. To operate the Intercom feature simply press and hold the "INTERCOM" key to talk to someone near the external speaker/microphone. When you have finished talking and upon the release of the "INTERCOM" key you will be able to listen-in to the external speaker/microphone. This listen-in capability will last from about 2 to 10 seconds depending on how the Intercom Module is adjusted. Potentiometer VR1 on the 7361 board controls this time. Potentiometer VR2 on the 7361 board controls the Intercom Volume Level (Refer to Figure 15 for the locations of these controls).

INSTALLATION OF THE MODEL 1520L OR 1522L SUPERVISED RF RECEIVER

If possible, locate both the 2720 control panel and the 1520L or 1522L as close to the center of the building as possible. Each RF receiver is shipped with a 4 ft long interconnect harness. This allows the RF receiver to be located at least 1 ft away from the metal control panel cabinet. It is important that the RF receiver be installed in an area not surrounded by metal or metal objects. Metal affects radio signals in such a way that will cause reduced reception in an RF receiver. Check for wire lath or foil backed insulation before committing to an installation location.

There are two wire harnesses supplied with each Model 1520L. When connecting a 1520L to a 2720 you must use both wire harnesses*. First, plug one end of the 14 conductor interconnect cable into the Model 1520L header, leaving the lower 8 pins of the header empty. Plug the other end of this cable into connector header P1 on the 2720 circuit board leaving the last 2 pins on the right side empty. Next, plug one end of the 10 conductor interconnect cable into the remaining 8 pins of the 1520L header. Plug the other end of this cable into the 2 remaining pins of connector header P1 on the 2720. Either let the unused portion of this connector extend beyond P1 or carefully cut the connector so that only the 2 conductors being used remain.

* The second (10 conductor) cable is only needed if you will be using RF zones to activate Fire or Emergency.

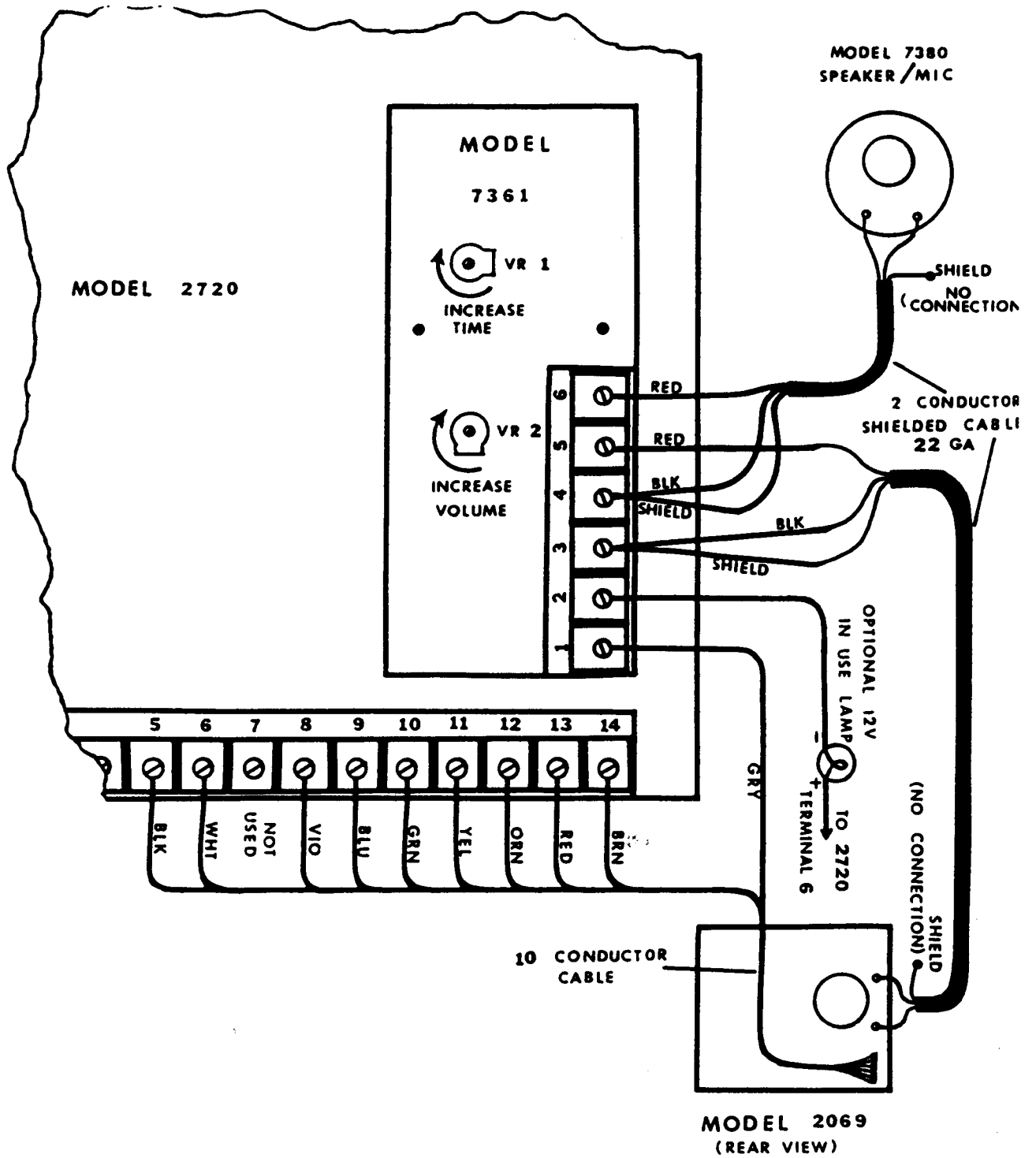

FIGURE 15
 MODEL 2720 INTERCOM WIRING

INSTALLATION OF THE MODEL 1520L OR 1522L SUPERVISED RF RECEIVER (CONTINUED)

There is only one wire harness shipped with each Silent Knight Model 1522L receiver. The 1522L header has 18 pin positions but only 14 will be used. Install the 14 pin interconnect cable so that the 4 pins closest to the edge of the 1522L circuit board are left empty. Plug the other end of this interconnect cable into connector header P1 on the 2720 circuit board, making sure to leave the 2 pins on the right hand side of the header empty.

RF ZONE - 2720 ZONE CROSS REFERENCE

The following list cross references the RF zone number with the affected 2720 zone. For example, the Trouble output of the RF receiver is connected to the Emergency zone Trouble input of the 2720.

PIN NUMBER	RF FUNCTION	2720 FUNCTION
1	Common Negative	Common Negative
2	+8 to +18 VDC	+12 VDC
3	Test Beep	Beep
4	* Trouble	Emergency Zone Trouble
5	Armed	Armed
6	Test	N/A
7	Zone 1	Zone 1
8	Zone 2	Zone 2
9	Zone 3	Zone 3
10	Zone 4	Zone 4
11	Zone 5	Zone 5
12	Zone 6	Zone 6
13	Zone 7	Zone 7
14	Zone 8	Zone 8
MODEL 1520L ONLY		
15	Zone 9	Fire Zone
16	Zone 10	Emergency Zone
17-22	Zone 11-16	Not Used with 2720

* **NOTE:** If RF trouble occurs, you may silence the periodic 10 second trouble tone in the normal way, but a 1 second tone every 60 seconds will continue. This distinguishes RF trouble from Emergency circuit trouble and will continue until RF trouble is resolved.

INSTALLING THE MODEL 5255 ON-SITE PRINTER

The Silent Knight Model 5255 On-Site Printer can be used with the Model 2720 Control Panel to provide a permanent record of all the 2720's activity. This will allow you to program the 2720 for minimum reporting to the Central Station, providing lower costs while still maintaining records of all activity. The 5255 is shipped with a 36 inch long, 16 conductor interconnect cable. One end of this cable is plugged into the connector header P1 on the 5255 circuit board and the other end is plugged into connector header P2 on the 2720 circuit board (Refer to Figure 1 in this manual and the printer manual). Install the 5255 as close as possible to the 2720 Control Panel (Not more than 36 inches away). Make sure that the jumper in the upper right hand corner of the Model 5255 circuit board is in position number 1. Please refer to the 5255 installation manual for more information about the printer.

TRANSIENT VOLTAGE PROTECTION

The Model 2720 Control Panel is protected from transient voltage damage due to lightning or static electricity, in several ways.

1. AC INPUT PROTECTION - Fast acting "Tranzorbs" (Model 7890) connected between each side of the Class II transformer and earth ground (Refer to Figure 2). MOV (Metal Oxide Varistor) protection between each side of the AC input and earth ground.
2. TELEPHONE CIRCUIT PROTECTION - MOV (Metal Oxide Varistor) protection between TIP, RING and earth ground. Line seizure relay provides an air gap between the 2720's internal circuitry and the phone lines.
3. LOOP INPUT PROTECTION - Fast acting Zener diode protection on all zones, between zone input and circuit ground.
4. SYSTEM PROTECTION BY DESIGN - The Model 2720 circuit board layout isolates vulnerable components from known transient sources.

EARTH GROUND

The key to any good transient voltage protection plan is making the proper earth ground connection to all protection devices. Failure to use all of the recommended protection devices will jeopardize the effectiveness of the protection plan.

Finding a good earth ground is always the first step. Connecting to a water pipe may not always provide an earth ground. Check for PVC (plastic) pipe. Electrical ground may not be at a true earth ground potential. Old and/or poor ground connections in the electrical system may allow electrical ground to float at some potential above earth ground. Be observant when selecting your ground source. When in doubt, a grounding rod should be driven into moist earth and used as the earth ground source.

2720 EARTH GROUND CONNECTIONS

1. Connect the Green wire attached to the 2720 circuit board, to earth ground.
2. Connect the common lead of the Model 7890 protection device to earth ground (via shielded two-conductor cable and the ground prong of the Class II transformer as shown in Figure 2).

NOTE: Never connect the system circuit ground to earth ground.

BATTERY TESTING

The Model 6812 Gell Cell backup battery is tested by the Model 2720 every 60 seconds. It is normal to see a slight drop in supply voltage every 60 seconds during this test. If the battery voltage drops below 10.2 volts during the test, a low battery signal is sent to the Central Station if the system is programmed to report trouble conditions.

SPECIAL APPLICATION SECTION

This section of the installation manual covers other areas of security where the Model 2720 may be applied.

MULTIPLE OFFICE OR STORE SECURITY

In this application, a single 2720 may be used to secure up to 8 individual offices or stores (shopping mall), while allowing individual arming/disarming or individual shunting/unshunting.

There are two ways that this may be accomplished.

METHOD I (Not to be used for installations in the state of California)

This method uses multiple Model 2070 keystations to shunt out 24 hour zones assigned to specific building spaces. Each building space to be protected would have its associated intrusion sensors connected to a specific 24 hour shuntable zone of the Model 2720. A Model 2070 keystation would be located outside the perimeter of each space, or at a location accessible by persons wishing to gain entry to this space. Each building space would be assigned its own access code that would allow only shunting and unshunting of that zone of protection. Example: Zone 5 is programmed as follows; EOL, 24 hour, shuntable. Steps 14.6 and 14.8 of the Control Prom Form have been selected. The access code starting with the digit 5 is allowed to shunt and unshunt zone 5, but only zone 5. Likewise, other access codes 1-8 can only shunt or unshunt their associated zones. Access code 0 still has full control over all zones and the rest of the security system. Code 0 should be reserved for building management people. This allows them to reset any alarms or gain access to areas of the entire building complex when necessary.

It is not necessary to use all 8 zones in this manner however. A system may be designed in such a way as to have only 1 or 2 zones programmed to function with "limited shunting" while allowing the remaining zones to be controlled by code 0 as part of a much larger building space to be protected.

METHOD II (Not to be use for installations in the state of California)

This method uses one or more Model 3500 Control Panels to provide security to one or more individual building spaces while using the Model 2720 as the single communicator for all building spaces. See Figure 16.

The Model 3500 allows separate Exit/Entry times for each building space to be secured. It also allows separate interior zone control, instant/delay functions, chime functions, two (2) user codes and various other benefits of the Model 3500.

The Model 3500 may be powered directly from the Model 2720, or if desired, it may be powered from its own transformer and standby battery, which allows the use of more auxiliary equipment when power capacity is a concern.

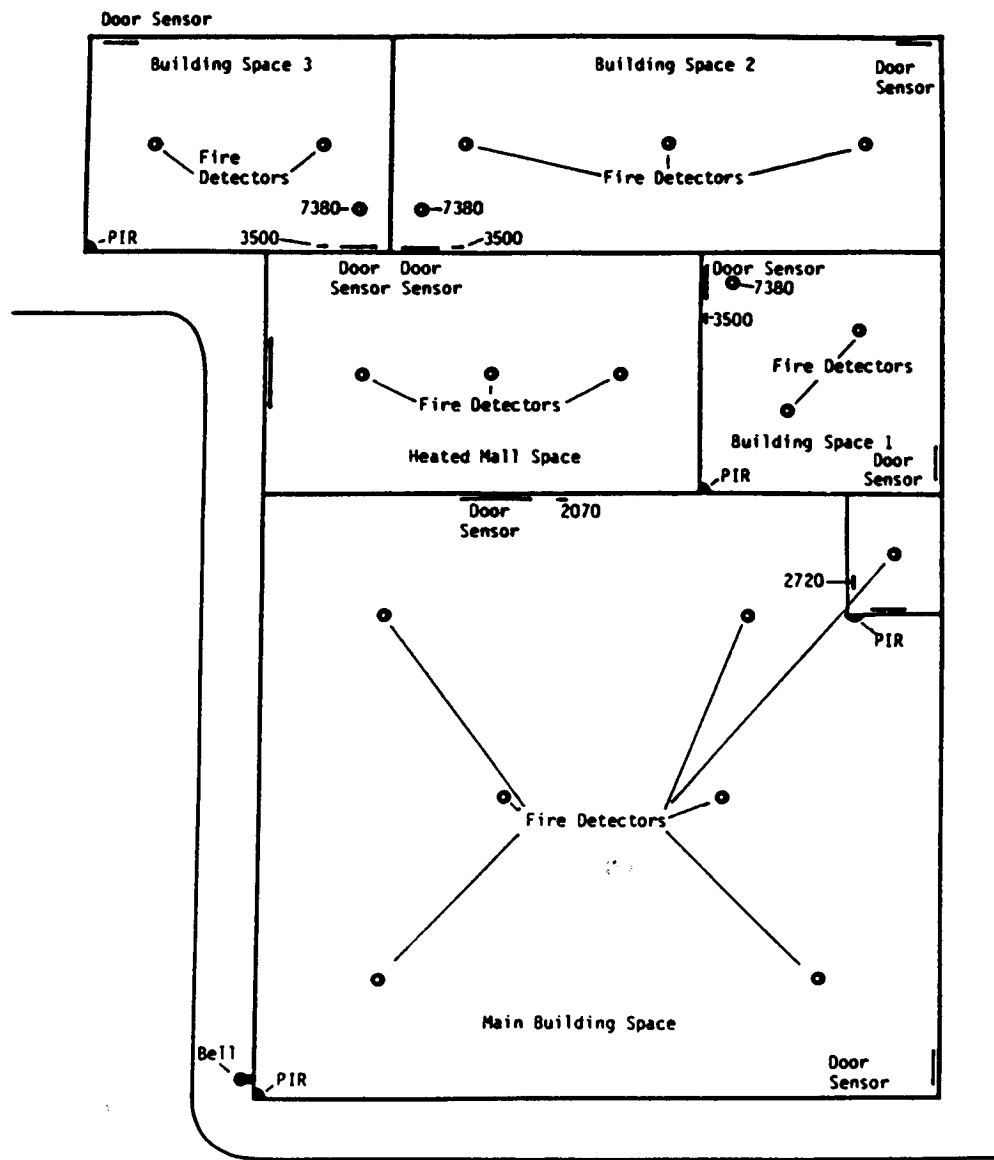

FIGURE 16

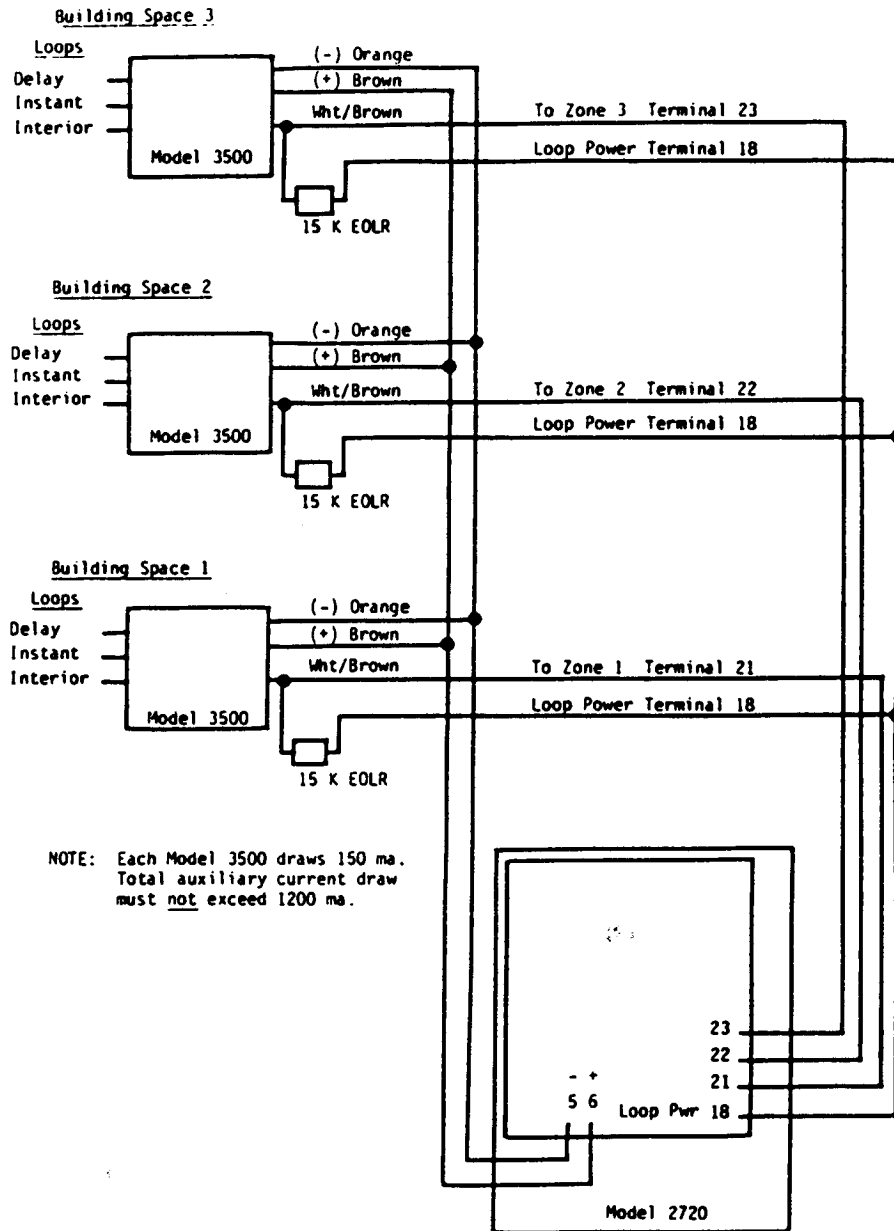

FIGURE 17

Each Model 3500 may be connected to its designated 24 hour. If desired, zone shunting may be inhibited for each of these zones to prevent unauthorized access.

A Model 2070 keystation may or may not need to be used depending on system requirements. A simple mechanical keyswitch may be used to reset alarms.

If it is desirable to trip more than one zone from each 3500, i.e. Fire, Burglary, Emergency, Trouble conditions, a Model 7145 relay module may be installed on the Model 3500 to provide up to 4 separate dry contacts per 3500.

NOTE: Silent alarms activated on the 3500 will NOT activate the switched ground alarm output. Do NOT use silent alarms with the Model 3500 unless you use a Model 7145 relay board.

Figure 17 shows the wiring of (3) Model 3500 control panels to the Model 2720.

Figure 16 is the shopping mall application that the (3) 3500 units are used in as an example. Also in this application, a Model 2070 keystation is used to control security for the main building space and the entire fire system for the shopping mall.

Care has been taken to be sure that total continuous current draw of all auxiliary equipment does not exceed 1200 mA. If need be, several of the Model 3500 control panels could be powered from their own transformers and standby batteries. If this was done, only the common negative references of each 3500 need be connected together to the negative reference of the Model 2720 (orange of the 3500's to terminal 5 of the 2720) and the positive lead of the 3500 left NOT connected to the 2720.

In the example shopping mall, it was decided that each store should have control over their own system. Any intrusion alarms would sound only in their locations. This is no problem as the Model 3500 has its own small alarm sounder. Also it was felt that if an accidental alarm occurred, it would be desirable to reset the alarm at the Model 3500 control panel and not necessarily at the 2070 keystation in the main building space. To accomplish all of these tasks, the 3 zones connected to the 3 Model 3500's were programmed as follows:

STEP #	ZONES	SELECTION
1	①②③④⑤⑥⑦⑧	End-Of-Line zones.
2	1 2 3 ④⑤⑥⑦ 8	Slow zones.
3	①②③ 4 5 6 7 ⑧	24 hour zones.
4	①②③ 4 5 6 7 ⑧	Silent zones.
5	1 2 3 ④ 5 6 7 8	Exit/Entry Delayed zones.
6	1 2 3 4 ⑤⑥ 7 8	Interior zones.
7	1 2 3 ④⑤⑥⑦⑧	Shuntable zones.

NOTE: Zones 1,2 and 3 are used for building spaces 1,2 and 3 only.

Also selected were the following steps:

- 13.1 Force Arm
 - .2 Auto Unshunt at Disarm
 - 3 Swinger Shunts
 - * 4 Fast Restore
 - 5 Exit Tone
 - 6 Bell Test at Arming
 - .7 Mechanical Key
 - 8 Duress Reporting
-
- 14.1 Interior Key disabled when Armed
 - 2 Interior Zones Delayed if they Follow Entry Zone
 - 3 Shunt Display Disabled when Armed
 - 4 Fire Audible Will Not Shutdown
 - 5 Silent Emergency Alarm
 - .6 Limited Shunting
 - 7 Codes 8 and 9 Cannot Disarm
 - .8 Codes 1-9 Cannot Arm or Disarm.

Zones 4-7 are used for the main building space, and zone 8 is reserved for the tamper circuit of both the 2720 cabinet and the alarm bell box.

The fire system for the entire mall was connected to the Class B Fire circuit of the Model 2720. Several 8 Ohm internal speakers were added for fire alarm annunciation.

* It is important that the fast restore option is used to enable building spaces 1,2 and 3 to restore the alarm if accidentally tripped.

The Central Station must interpret the following:

- Account Number = Entire Mall.
- Alarm Zone 11-13 = Building Spaces 1-3 in Intrusion Alarm.
- Restore Zone 11-13 = Shutdown of Alarm 1-3, must call back and ask for verification code number.
- Alarm Zone 14-17 = Intrusion Alarm In Main Building Space.
- Restore Zone 14-17 = Possible Fast Restore or Keypad Reset of Zones 4-7. Call Police first, then call for verification in case of user false trip. If user verifies false trip, cancel alarm.
- Alarm Zone 18 = Tamper Alarm.
- Alarm Zone 09 = Duress Alarm in Main Building Space.
- Alarm Zone 02 = Fire Alarm in Shopping Mall.
- Alarm Zone 03 = Emergency in Main Building Space.

The previous example used the Silent Knight FSK reporting format. This example is just one possible method of providing security for the shopping mall, others are possible.

If you have any questions about this example or have ideas for another solution, contact Silent Knight Customer Service at 1-800-328-0103.

POST-INSTALLATION TEST

Because of the flexibility of the 2720 system, many combinations of operation and reaction to sensor activity may occur. It is important that every desired feature be fully tested, i.e., time factors, loop responses, audible functions etc.

All questions concerning system programming and operation should be directed to Silent Knight Customer Service, Telephone 1-800-328-0103. Any errors or omissions in this manual should also be reported to Silent Knight Customer Service. Your suggestions and advice on product application is always welcomed.

<u>TERMINAL NUMBER</u>	<u>TERMINAL DESIGNATION</u>	<u>NOMINAL VOLTAGE READING</u>
21	Z1	0 VDC normal if N.O., 2.3 VDC normal if N.C., 13 VDC alarm if N.O., 0 VDC alarm if N.C.
	through	
28	Z8	0 VDC normal if N.O., 2.3 VDC normal if N.C., 13 VDC alarm if N.O., 0 VDC alarm if N.C.
29	GS	13 VDC normal (if connected to relay) <1 VDC active
30	TIP	0 VDC (isolated), 48 VDC Tip to Ring nominal "on-hook."
31	RING	0 VDC (isolated), 48 VDC Tip to Ring nominal "on-hook."
32	T1	0 VDC (isolated)
33	R1	0 VDC (isolated)

FSK REPORTING

As a result of design changes to enhance the reporting capabilities of the Model 2720, an adjustment of the "FSK" card of the Models 8510 and 8520 may be required. This adjustment is only required if you intend to use the "FSK" reporting option of the 2720 and then only if the Model 8510 and/or 8520 has not already been factory adjusted.

If, when the 2720 reports to the 8510/8520, the data does not display, but instead, the display shows "B"s and/or "C"s, or a blank display, the "FSK" card must be adjusted.

To do this, remove the six phillips head screws holding the receiver back panel in place.

Carefully slide the receiver section out until the fourth card (counting from the rear) is exposed. (See Figure A)

Note the present position of the slot of the potentiometer labeled (P1) in Figure B.

Using a small bladed screwdriver, turn the slot of P1 3/4 of a turn in the CLOCKWISE direction.

Carefully replace the receiver and secure with the six phillips head screws.

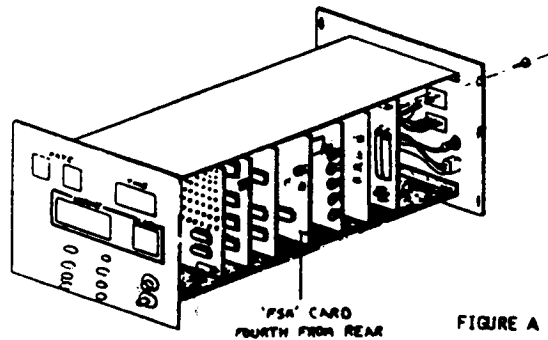

FIGURE A

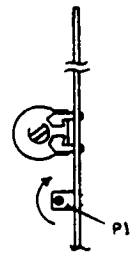

FIGURE B